



THE LID

A MAGAZINE DEVOTED ENTIRELY TO THE WIRELESS AMATEUR

LIBERTY  
NUMBER

NOVEMBER  
1919

PRICE  
15¢



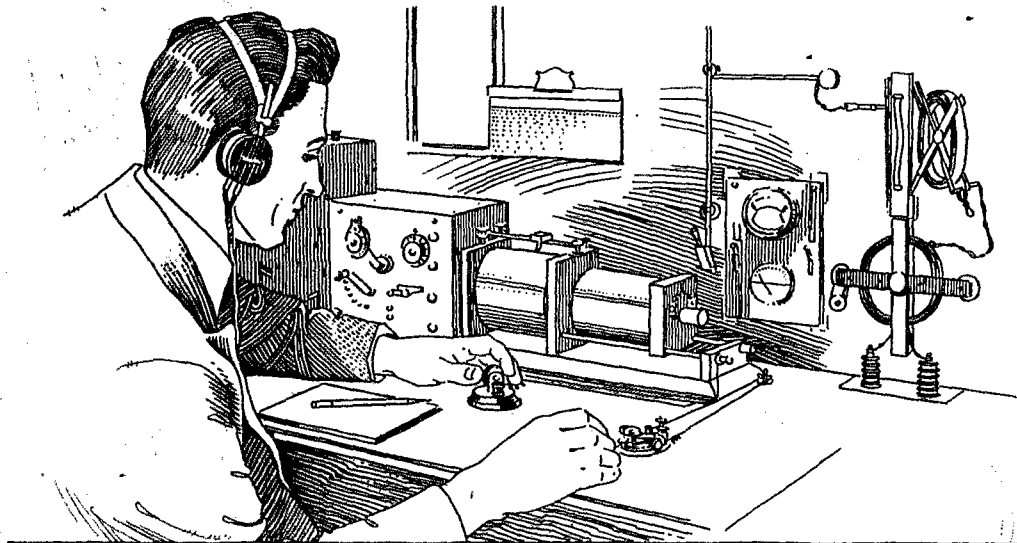

*Thousands  
in successful use ~*

If the experience of others is anything to go by you want a Crystaloi Detector.

Our files are full of the most enthusiastic endorsements from thousands of users.

The ease with which it enables you to get the best quality in a signal—its simplicity of operation and the fact that it is inexpensive to operate make it the ideal Crystal Detector for the amateur and professional alike.

**PRICES**

Type O. Crystaloi Detector	\$3.50
By parcel post prepaid	3.60
Type A.A. Crystaloi Detector	6.00
By parcel post prepaid	6.20

BOOKLET ON REQUEST

**CONNECTICUT TELEPHONE & ELECTRIC COMPANY, Inc.**  
**MERIDEN, CONNECTICUT**

All rights and patents under which the Crystaloi is made were purchased from the inventor, Eugene A. Turney

**Crystaloi**  
*Detector*

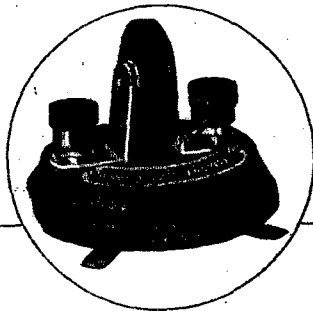

# QST

VOLUME III

NOVEMBER, 1919

NO. 4

## CONTENTS

- 3 The Importance of our A.R.R.L. Hiram Percy Maxim  
5 The Champion of the Amateurs  
5 Obituary—Clarence W. Brown  
5 Erratum  
6 The Photo-Electric Cell and Its Possibilities  
    in Radio Communication Herbert E. Metcalf  
9 Rotten Impulse Excitation "The Old Man"  
10 Some Dope on Hook-ups  
12 Getting Your Licenses  
13 Editorials  
17 Calibrating Your WaveMeter  
18 QST Subscription Contest  
22 The Operating Department  
26 Harmonics  
27 Notes on the Quenched Gap for Amateur  
    Use H. J. Tyzzer  
29 Who's Who in Amateur Wireless  
30 U-Boat Radio J. A. Crowdus  
32 "Strays"  
34 The Junior Operator  
36 Radio Communications by the Amateurs  
40 Transmitter Efficiency M. B. West  
42 QST's Directory of Calls

QST is published monthly by The American Radio Relay League, Inc., at Hartford, Conn. Kenneth B. Warner (Secretary, A. R. R. L.), Manager and Editor.

Subscription price, \$1.50 per year in the United States and possessions;  
Canada, \$1.75; Foreign, \$2.00. Single Copies, 15 Cents.

Entered as second-class matter May 29, 1919, at the post office at Hartford, Connecticut, under the Act of March 3, 1879.

Copyright, 1919, by The American Radio Relay League, Inc.  
Title registered at United States Patent Office.

THE AMERICAN RADIO RELAY LEAGUE, Inc.  
HARTFORD, CONN.

# HAVE YOU CONSIDERED

THAT it *does* make a difference where you purchase your apparatus?

THAT service, a congenial atmosphere and a genuine interest in the amateur—plus a high grade line of radio supplies *must* give real satisfaction?

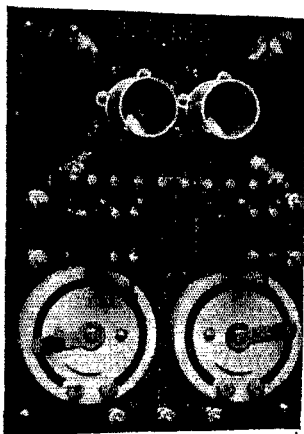

"TRIODE E"  
TWO STAGE  
AMPLIFIER  
Price \$39.00

The illustration shows our New Two-Stage Amplifier—designed for the amateur. A feature of construction is the shock-proof tube mounting eliminating breakage.

Price \$39.00

W. S. A. Amplifying Transformer, \$7.00

---

---

## ATLANTIC RADIO COMPANY

34 BATTERY MARCH ST.  
BOSTON, MASS.

WRITE FOR  
BULLETIN 10

# Q S T

A Magazine Devoted Exclusively  
to the Radio Amateur

## *The Importance of our A. R. R. L.*

*By Hiram Percy Maxim*

**T**HE removal of all war time restrictions on amateur radio marks the ending of one chapter and the beginning of a new chapter in amateur radio history. The new is going to be entirely different from the old. Wonderful things were brought to pass in the old; but immensely more wonderful things are going to be brought to pass in the new. Before we become engrossed in our new conditions, it is well to consider what are the important things which should govern us.

When amateur radio is examined critically, the fact is borne in upon one that the foundation stone upon which we have built those successes which we have achieved has been ORGANIZATION. Our American Radio Relay League, with its strictly amateur organization, and its ability to represent the better amateurs of the country as a solid body, has exerted more real beneficial influence than is generally appreciated. There is a terrible difference between an unorganized, incoherent, uncontrolled crowd and an organized, coherent and orderly body. One can attain almost nothing. The other can perform wonders, even miracles, if the organization is perfect enough. A tug-of-war team, well organized and controlled can pull off its feet an unorganized crowd of three times its numbers. One acts as a body, a united whole, under formulated plans worked out in advance. The other acts separately, individually, no two pull at the same time nor in the same direction and there are a thousand plans and no control.

We amateurs were an unorganized crowd, any way as regards the country as a whole, before the days of our American Radio Relay League. We had no established national standing, because we had no national organization. There were a good many of us, but we were scattered. We were regarded with mild interest by some, and with mingled tolerance and amusement generally. If it had not been for certain local clubs and associations, who undertook the work of protecting amateur interests generally, there is no telling what might have happened to amateur radio in the legislation of 1912. Reference is made particularly to the splendid work done by the Pennsylvania Wireless Association in the early days.

The importance of organization is splendidly exemplified in recent times. We never could have built up our Trans-Continental nor our Inter-State relay systems had we not got together, acted as a National body and worked out the problems systematically. We never could have brought to the Army and Navy the flood of experienced radio operators which we did bring in those first critical days, if it had not been for our National organization. This record will stand on the pages of history more distinctly as the years roll on. It was a noble effort for all concerned, and lifted amateur radio from the realm of toyland to the dignity of a valuable National asset. Our organization made it possible to present the facts from the country's standpoint to a great body of amateur operators

whose method of thought had previously been trained in the right direction.

An example of the value of organization is the vigorous and successful opposition our American Radio Relay League was able to exert in the last twelve months when legislation was attempted by the Navy Department, which many of us think would have made easy the total elimination of amateur radio, if some unfriendly authority desired to do so. Through our organization we were able to bring countless remonstrances from every State of the Union. Congressmen in Washington had their attention directed to amateur radio and had the facts explained to them in an incredibly short time. The pressure of opposition was so strong and was based upon such uniformly reasonable grounds, that the Committee having the proposed legislation in charge actually declined to report the bill out. It died in Committee, and the incident is an example of the value of organization which every amateur should keep in mind and explain to those to whom the value of organization is not apparent. There always are some among us who oppose order and system and constituted authority. As in other walks of life, we must constantly exert ourselves to overcome the unfavorable influence which these sort of people encourage.

There are very impressive examples of the benefits of organization in other activities. Labor is one. It was only able to make its voice heard and its influence felt when organization was so perfected that laboring men became an organized, systematically controlled, single minded body of men. Almost every business had to organize associations for mutual protection. We have manufacturing associations, sales associations, agricultural associations, financial associations, scientific associations, in fact hardly a branch of human activity has not found it either desirable or absolutely necessary to organize for mutual improvement or for protection against elimination. Automobile owners are one of the recent groups of individuals who were most difficult to organize, and yet who had the most to gain from organization. The youngest of us must remember how country constables

set speed traps and arrested automobile owners by the wholesale for trivial technicalities. It became a form of piracy which equalled the most prosperous days of the old sea-rovers. It was not until automobile clubs of the American Automobile Association were formed all over the country that sufficient influence could be brought to bear to have just laws passed and unjust laws repealed.

Amateur radio station owners and experimenters are in many cases young men who have not yet been in contact with the affairs of the world. It is difficult for them to realize the supreme importance of organization, and that little modicum of unselfishness that is necessary in order to bring about perfect organizations. There is no such thing as organization if each one of us starts out to be thoroughly selfish. If all our efforts are to be directed solely for the benefit of self, we are purely individual and able to take about as much form as the individual sands of the sea. We are an incoherent, uncontrolled crowd. On the other hand, if just a little of our efforts is devoted to THE COMMON CAUSE, we automatically establish organization and efficiency and protection, and everything else that is elevating, improving and worth the having. The only thing we have to sacrifice when we organize is that amount of time and effort that is necessary to enroll one's name, and that amount of money that is necessary to pay yearly dues. The rest takes care of itself, automatically. When an amateur asks that old time question, "What do I get out of joining the A.R.R.L.?", the answer should be, PROTECTION. He cannot have it unless somebody joins an organization and does the work. Unless he joins and does his bit, he must not complain when his fellows place him in that list of unenviables who are not willing to do any work themselves but who will accept the results of what the other fellow does.

A most impressive example of the possibilities of amateur radio organization is the results achieved by our Traffic Department. I have been told by outsiders that when the monthly reports of the Traffic

(Concluded on page 8)

## The Champion of the Amateurs

**F**RIENDS, it gives us pleasure to present to you Honorable William Stedman Greene, Chairman of the House Committee on The Merchant Marine and Fisheries, loyal protector of amateur rights, confounder of all government-ownership programs, and for the past twenty-one years Representative in Congress from the State of Massachusetts.

Mr. Greene it was who undertook to present the case of the amateurs in our effort to secure reopening. When our Committee went down to Washington we found a real sympathizer in Mr. Greene. Once he had been informed of the situation he went to work, and within a month—Presto! we are open! It seems only fair now to let out the story of how our reopening was accomplished. We talked the matter over with Mr. Greene and the first step seemed to be to find out why we were still closed, so Mr. Greene prepared and introduced for us a resolution asking the Navy Department to explain the reasons why we weren't opened, and at the hearings on this resolution the House Committee let it be known that they strongly favored our early resumption of operation. As time went by without the appearance of any results from this Mr. Greene again prepared a resolution and in-

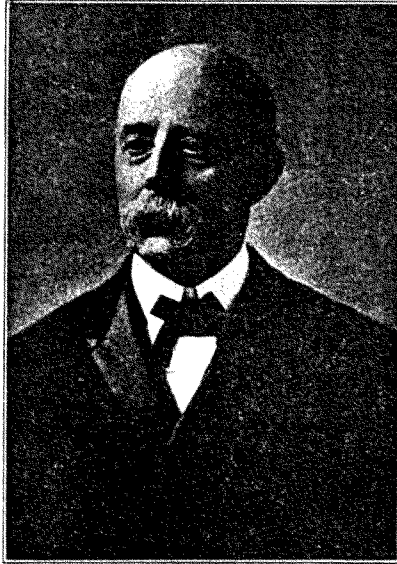

HON. WM. S. GREENE

roduced it, and this document is one which will ever have a place in amateur history. Known as H. J. Res. 217, it reads as follows:

"Joint Resolution, to direct the Secretary of the Navy to remove the restrictions on the use and operation of amateur radio stations throughout the United States. Resolved by the Senate and House of Representatives of the United States of America in Congress assembled, that the Secretary of the Navy be, and he is hereby, directed to remove the restrictions now existing on the use and operation of amateur radio stations through out the United States."

Mr. Greene was born in Illinois in 1841 but removed with his parents in 1844 to Fall River, Mass., which has since been his home. Entering politics in the year 1876, he has had a varied and useful career in his chosen field, serving as Mayor of Fall River for seven terms, and twice as Postmaster. While Postmaster in 1898 he was elected to an unexpired term in the 55th Congress, and has since served continuously, being one of the oldest members of Congress in point of service.

We all feel a deep sense of gratitude to Mr. Greene for his splendid efforts in our behalf. Our sincere and hearty thanks are yours, Mr. Greene.

### OBITUARY

The death of Clarence W. Brown, of SADP, Akron, Ohio, on October 2nd, came as a shock to his many friends, many of whom were radio amateurs throughout northern Ohio and western Pennsylvania.

Mr. Brown was a recent Curtis Aviation School graduate and a licensed aviator, and was one of the members of the Ohio Aviation School, located east of Lorain, Ohio. It is believed that while in the air some control on the plane broke, causing the machine to crash to earth and resulting in the death of Brown and his passenger.

Mr. Brown was quite an amateur radio

### ERRATUM

On page 4 of the October QST, in the description of Mr. Seabury's oscillator, the capacity of the condenser C4 was erroneously shown as .005 mfd. It should have been .0005 mfd., the same as condenser C3.

enthusiast, having been President of the Akron Radio and West High Radio Clubs. Only a day or two before the accident he had erected a station, planning to be in on the A.R.R.L. relaying when the ban lifted.

## The Photo-Electric Cell and its Possibilities in Radio Communication

By Herbert E. Metcalf

We QSTists are a pretty practical bunch, and it isn't often we can indulge in a purely speculative article, but here is one which offers possibilities for development at our hands, and that is what we are looking for.—Editor

**T**HE photo-electric cell, as its name implies, has to do with both light and electricity. It is primarily a device where-by a current is made to flow under the action of light, and in that respect may be compared with a selenium cell. The comparison ends there, however, and in the nature of its action it is far removed from cells of selenium and similar compounds.

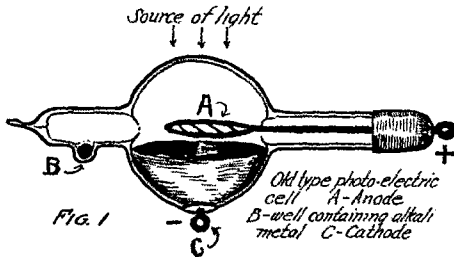

Briefly it is composed of a tube containing two electrodes, anode and cathode, the anode being of platinum and the cathode consisting of a highly sensitized film of an alkali metal in its pure state. Its common function in the scientific world is in the photometry of stars, for which purpose it has been highly developed by Dr. Jacob Kunz of the University of Illinois, to whom I am indebted for a great deal of the information contained herein.

One form of the cell is shown in Fig. 1. The glass bulb contains a platinum ring on an arm, as an anode (A), and one half of the bulb has been silvered, making a hemi-spherical mirror. The tube is highly exhausted on a mercury pump, and then a small quantity of a pure alkali metal (sodium, potassium, etc.) which has been included in a small well in the tube (B) is carefully distilled onto the silver mirror. This is accomplished by having a heating coil which heats all the glass to above the condensation temperature of the alkali, except that portion where the metal is to be deposited, which in this case is of course the silver mirror. That portion of the cell is kept cold by means of a water bath in order to hasten the condensation of the metal. The most sensitive cells are those in which the metal has been deposited on

the mirror in a thin uniform layer. Then the layer must be sensitized. A platinum wire sealed into the glass in the center of the mirror makes contact with the deposit, to form the cathode. With a potential difference of from 280 to 400 volts between anode and cathode, pure hydrogen is admitted and its pressure so adjusted as to produce a uniform glow discharge at this voltage. During this glow the surface of the alkali metal is undergoing a change and a hydride is forming. This development must not progress too far, and the sensitiveness is continually tested while the hydride is forming. When the proper sensitivity is reached the hydrogen is pumped out and an inert gas such as argon, helium or neon is admitted, for the purpose of maintaining the stability of the combination. The best combination for maximum sensitivity is a cell made from rubidium, sensitized with hydrogen, and filled with Neon.

So much for the actual construction of the cell. Its action is very simple. When a potential is applied to the "plate" of about 300 volts positive, any small amount of light falling on the sensitized film will cause a deflection of a galvanometer inserted in the plate circuit, and changes in the amount of light will be indicated. The device is so sensitive that by allowing the light of different stars to fall upon the tube their brilliancy can be accurately compared.

The space within the tube, while not a vacuum, is not a conductor, and the current flow seems to be electronic. This view is supported by the fact that originally the

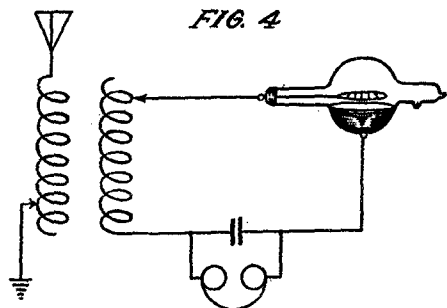



tubes were made with a vacuum and later the discovery was made that the presence of the gas lent stability to the hydride. From this we might say that the hydride layer emits electrons under the impact of light and ionization by collision is also probably a factor. It is not surprising therefore, that curves comparable with the plate-current—filament-current curves of a two-electrode vacuum tube at various plate voltages can be made of the photoelectric cell, in the latter case showing the relation of plate current to intensity of illumination. This is depicted in Fig. 2. The abscissae are distances in centimeters, varying from 40 cms. to 300 cms. between the cell and a 388 c.p. tungsten light. In Fig. 3 are shown several plate-voltage—plate current curves at a fixed illumination, the different curves being obtained by varying the distance between electrodes. These curves may be likened to vacuum tube curves of the same kind for various fixed filament currents.

The sensitivity of the cell as it exists at present may be expressed by the assumption arrived at mathematically by J. G. Kemp (to whom credit is due for the above curves) that by using a tilted electroscope of sensibility  $10^{-16}$  amperes, the light of a candle could be detected at a distance of 2.7 miles.

Some work was done by the author to determine whether or not this tube contained any great possibilities for use in radio reception. It has already been used and described by Kunz (1912) as a rectifier and detector, used in place of a crystal detector, exactly as the Fleming valve, with no plate voltage. See Fig. 4. This hookup was tried and very good results obtained, provided a strong light was allowed to fall on the tube. If the tube was in the direct sun, with no plate voltage the signals were fully as good as

the best crystal detector, and of excellent quality, sounding like those from a tube detector rather than from a crystal. It is unfortunate that an oscillograph record of its rectifying qualities could not be made, but it is hoped that this may be done in the future. In this hookup the tube was extremely sensitive to light, the strength of signal being easily changed by walking between the tube and the window, when out of the direct sunlight. When a slight voltage is applied to the plate, the reaction to light is greatly increased but the strength of signals is unchanged or slightly decreased. The curves of Fig. 3 show an extremely abrupt change in plate current at a very critical value of plate voltage, but the difficulty of practical utilization of this feature lies in its very criticalness, which no doubt accounted for the writer's failure to obtain increased signal strength with the use of a plate potential. If the axis of operation could be definitely located in the region of one of these bends, the sensitivity as a detector would far exceed that of present three-electrode vacuum tubes. If the tube is exposed to the direct sun, with a small positive potential on the plate, and the hand passed between the sun and tube, a dull thud may be heard as the current drops and rises again after the light is readmitted. The experiment was tried of placing an electric fan so that the revolving blades would interrupt the light, and in this way a note in a telephone receiver was obtained varying from zero up to and beyond audibility, as the fan speed was increased.

The main drawback with the tube at present is that the actual current in the cell, using a considerable plate battery, is very small—of the order of micro-amperes instead of milli-amperes as in an ordinary vacuum tube. Recently, however, a tube

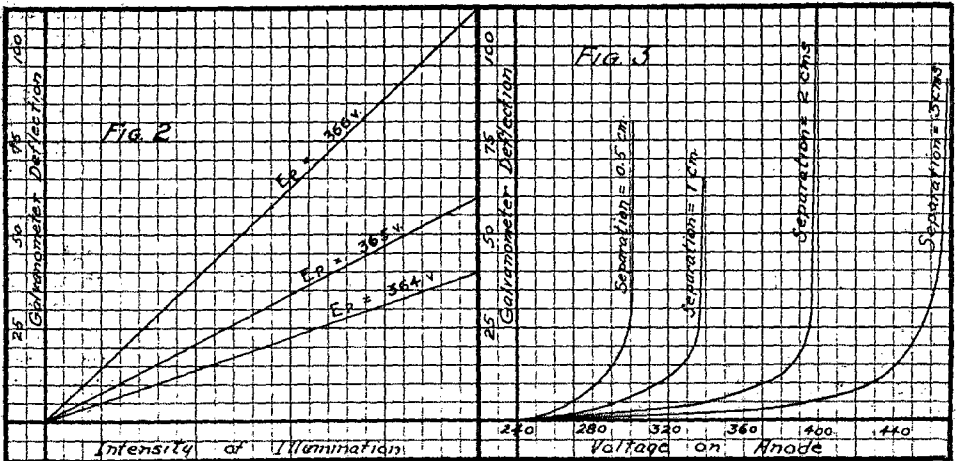

was designed by Dr. Kunz which gives considerably more current and may be made even larger so that currents approximating those in modern vacuum tubes may finally be obtained. This design is shown in Fig. 5, and it will be noted has a plane aluminum disc bearing the hydride film, and a circular aluminum plate provided with a screened central aperture to admit the light rays. The closer spacing of the electrodes reduces the internal impedance, and with the larger surface it would appear that hope might be entertained for eventually securing a greatly increased plate current with moderate anode voltages. Some work was done by the writer which indicated that this tube might be used as a true relay detector by the introduction of a grid. A measurable control from an exterior grid was observed, but not sufficient to use in the reception of signals or to take curves. The possibility also exists of having the incoming voltage vary the potential across a fine lighted filament furnishing the illumination, and so cause responses from the cell.

The possibilities suggested by a study of this cell are many. The writer has already produced an alternating current in the plate circuit by rotating a fan in front of the cell. Might not some means be hit upon to produce radio-frequent oscillations? Would this cell produce radio-frequent oscillations if exposed to a radio-

frequency spark discharge from a capacity? Would not the cell as it is make a wonderful detector for telephonic transmission over a beam of light? The writer believes

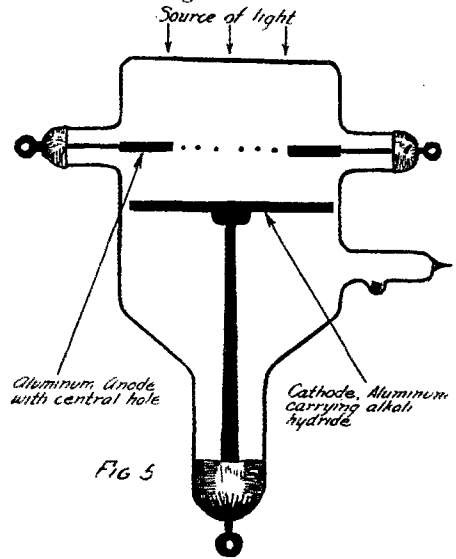

that with proper research the photo-electric cell can be developed to a point of great value in many and various ways in radio communication.

## The Importance of our A. R. R. L.

(Concluded from page 4)

Department in QST are read, it is difficult to believe that a stage has been reached such as described. The fact that in the great areas of the far western States, where they have miles where we have yards, and where the population is a single individual where we in the East have one hundred, there are well organized lines of amateur radio relay stations fills the ordinary person's mind with amazement and admiration. We ourselves who have seen this organization of stations gradually form itself, do not fully appreciate what it all means, and the far reaching possibilities which it suggests. It would indeed be rash to attempt to predict where our A.R.R.L. relay system will eventually bring us. It is one of the wonderful by-products of democracy. Up

to the time that we amateurs began relay work, the limit which one could transmit intelligence without paying tribute either to the Government or the Western Union or the Postal Telegraph Company, was the distance one's voice would carry. Today, we American citizens of the A.R.R.L. and our friends may communicate with each other from the Atlantic to the Pacific Coast and from within the Dominion of Canada to the Mexican Border, without paying tribute to anybody, without costing any money, and purely through the fact that we are organized to do this work. It is indeed a wonderful achievement, and assures the safety of the statement made earlier, that very wonderful things indeed are to come in amateur radio. Organization will guarantee them.

## Rotten Impulse Excitation

By The Old Man

**S**O you want some comment from those who have had experience with Impulse Excitation? Well Son, I have had experience, and I say right here and now, that if Impulse or Outpulse or any other kind of Pulse will get a full size kilowatt into a 200 meter wave without blowing a hole through something, you can count upon yours truly for any and all the comments you want. Comment! Why, say boy, I would be ashamed to say what my comments would be like, if I could only get a full count of a thousand of those little watt things into a 200 meter transmitter. Comment is easy; but eight honest amperes radiation on 200 meters is not so easy.

This Impulse Poison soaked into my system against my will after reading your dope in October QST. I wonder if you know how much harm you do, and how much trouble you cause, passing out this sweet sounding stuff. If it gets an old bird like me once in a while, what does it do to these young things who have not yet traveled the long and dusty radio road? Your song sounded so sweet and easy that I just could not keep from thinking about it. No resonance—any old “whale of a condenser”—any old amount of power—no reason why there should be any limit to radiation on 200 meters. If that bait don't catch both old and young, then I miss my guess. All you have to have is a rotary gap that will quench. All you have to have to quench is a gap that buzzes around so spry that the closed circuit only has time for one healthy wiggle. So simple!

I had a conviction that my Old Betsy was the kind of a gap that would quench or do any thing else that was noisy. Could it be that this simple little expedient would give me those precious eight amperes I had been longing for all these years? Old Betsy certainly was some gay little twister, and your dope certainly stated in distinct language that if a rotary twists around fast enough so that the plugs get to dodging one another smart enough, the job is done. Only one or one and a half oscillations have time to enjoy their brief career in the closed circuit, while the antenna and the O.T. secondary go on about their own business and give you the pure wave and all the other nice things. I decided to see what Old Betsy could do, what a real man's size condenser could do, and what a real full sized kilowatt could do. Maybe I would see the old H.W.A. pointing at eight amperes after all.

I greased the old girl especially carefully, trimmed her plugs until they only cleared by a few thousandths, took half an inch out of her driving belt, and got her so she simply yelled bloody murder. Good Lord, how she did twist around. By the sound, those plugs sure were dodging each other. In fact, I kept dodging myself, thinking any minute the plugs might be after me, being somewhat confused on account of dizziness, as to who was playing in this dodging game with them. Then I put in six condenser jars where two was the legal limit if we confine ourselves to old fashioned resonance between closed and open circuits. These six condensers would be a “whale of a condenser” all right, and would make my wave length in the closed circuit somewhere in the neighborhood of 500 meters, with an ordinary spark gap. This ought to give the secondary of the O.T. something of a whallop all right. Maybe things would not be in resonance, but then Impulse Excitation was to attend to this little discrepancy. Maintaining four turns in the O.T. secondary would keep me out of trouble with the Department of Commerce.

When I started her up, the little wife ran out into the back yard, where it was safe and called to me to state my intentions regarding the future of herself and the rest of the family. I didn't blame her, because that cellar was quite a noisy little corner. Everything was boiling hot if it wasn't red hot. Old Betsy was screeching for blood at the top of her cat voice, the condensers were squirting blue fire all over the place, and the transformer safety gap was going off every now and again like a machine gun in a reckless state of intoxication. Judging by the clatter, I ought to be getting around eighteen amperes, and I felt some elated.

When I got up the nerve to stand close enough to throw the H.W.A. switch, I found that I was radiating just a little over one-half ampere. Everything had turned out just exactly the way it always does in radio. Instead of getting eight amperes I wasn't getting eight-tenths of an ampere, and you could hear the racket in the next county. Before shutting her down, I was enough of a hero to reach over and change the O.T. primary to about three-quarters of a turn, and the O.T. secondary to every doggone inch there was in the thing. This was a sacrifice on the altar of resonance. I thought, before the whole business tore itself to pieces, I would at least try it as near resonance as I could

get. It raised the radiation to close on to six-tenths of an ampere. Then I shut her down and went outside and lighted the old pipe.

Some pretty little efficiency, this Impulse Excitation hook-up. With all the O.T. primary out that I could get out and still have it bear some resemblance to an O.T. primary, and with all the O.T. secondary in, that there was to put in, and with close up to a kilowatt going into the transformer, and with six big fat Marconi Leyden jars, and with Old Betsy just splitting the welkin, I was getting very close to half an ampere radiation in my antenna. Then the old pipe began to get in its work. Suppose now, we forget the impulse excitement for a while and suppose we take out two of the condenser jars, and then suppose that we lower the transformer input down to about one-half kilowatt, which is all that will not spill at the safety gap. Supposing also, we bring the O.T. secondary back to four turns which gives us 200 meters, taking advantage of our ten per cent allowance, and suppose we give the O.T. primary a chance for its white alley by putting in, say two turns. This would be somewhere near resonance. What would the result be? Of course, there would be only half as much power input, and we could not expect a whole

lot of improvement. But just the same, why not see just how much improvement there would be? So spake the old pipe.

Back to the cellar. Out with sixty-six per cent of the condenser capacity. Down with fifty per cent of the transformer input. Back to four turns on the open circuit. Try her with two turns on the closed circuit. Start her up, stand back from Old Betsy, and when she reaches her top note, throw in the H.W.A. switch. We smiled, the old pipe and I. Three and one-half amperes radiation. Sliding the O.T. primary clip back and forth finally made it three and three-quarters amperes radiation. Say boy, how about it? Half as much input and three times as much output!

Has anybody any comments to make? If he has, let him shoot. Is there any more swan-song business? Don't monkey with the gap, because my Old Betsy is a quick mover, and I don't believe one can be made that will be much quicker. Give us something about resistance in the closed circuit, or booze inside the gap, or two or three gaps in series. I suppose I will fall for it, along with the others. It's just awful what a man will do in the hopes of getting one K. W. into 200 meters.

T.O.M.

## SOME DOPE ON HOOK-UPS

**T**HERE seems no end to innovations in undamped circuits. In Figure 1 is presented an idea for an oscillating hookup which may be employed to advantage by those of our readers who possess "Jumbo"

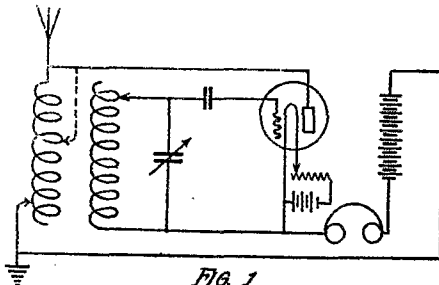

FIG. 1

loose-couplers for receiving long waves. This circuit was sent us by Mr. A. Dean Snyder, of Philadelphia, who chanced upon it while endeavoring to improve upon an oscillating circuit which, in the Philadelphia district at least, is generally known as the Chambers circuit, and was published in QST for August, 1916. This Chambers circuit, also designed for use with large loose-couplers, has the merit of extreme

simplicity, differing from the conventional audion hookup only in the presence of a metallic connection from the antenna end of the primary to the plate of the tube. Mr. Snyder's circuit utilizes the primary inductance as the tickler, it will be noted, and is simply a clever means of accomplishing an inductive feedback without the use of a third inductance. It would be well to insert a 2 mfd. insulating condenser in the ground lead. This circuit is reported to be extremely stable in operation and will oscillate over the entire range of the coupler. While the work Mr. Snyder has done with it speaks for its efficacy, it is regarded as desirable that the degree of feedback be controlled, and this could be simply accomplished by the use of a second slider on the primary, as shown by the dotted line.

There are of course an infinite variety of undamped hookups, and we can now make our inductances or choose from several makes of manufactured ones, and can employ either inductive or capacitive feedback to obtain oscillations. The favorite circuit seems easily to be the old reliable tickler arrangement (Fig. 4, page 4, October QST) with three coils. We wonder if any purchasers of deForest honeycomb

coils are employing the deForest three-coil anti-static circuit? Correctly handled, this circuit is surprising in its selectivity and freedom from static but in general is not nearly as effective as the tickler circuit. We imagine it is advocated only on account of patent reasons, the tickler hookup being an Armstrong circuit which the deForest people cannot advertise, and that they trust in the intelligence of the purchaser to discover that the "three-coil mounting" lends itself admirably to the use of the latter circuit, employing the stationary coil as the secondary, with movable primary and tickler on either side.

While good results may be had by tuning the plate circuit by means of a capacity around the tickler, this method is uncommon and the more satisfactory method is to eliminate the condenser and let the plate circuit function aperiodically.

A word about amplifiers. Resistance repeaters are unsatisfactory for short

weak signals, but iron losses preclude the use of very high turns-ratios.

The Federal amplifying transformers employ 3900 turns of No. 44 enameled wire on the primary and 12,000 turns on the secondary, giving a ratio of slightly over 3. The Acme transformer has 4000 turns primary and 15,000 turns secondary, all of No. 40 enameled; the primary impedance is approximately 1000 ohms and that of the secondary nearly 6000, these values being obtained by winding the primary under the secondary. This latter point it is well to note, for since the secondary turns are of larger diameter, an impedance value more appropriate for the tube can be secured without excessive turns. With some tubes the desirability of securing correct values of impedance offsets the value of a voltage step-up, and Mr. A. H. Wood, Jr., of the Clapp-Eastham Co., has supplied us with the specifications for a transformer embodying a lower turns-ratio

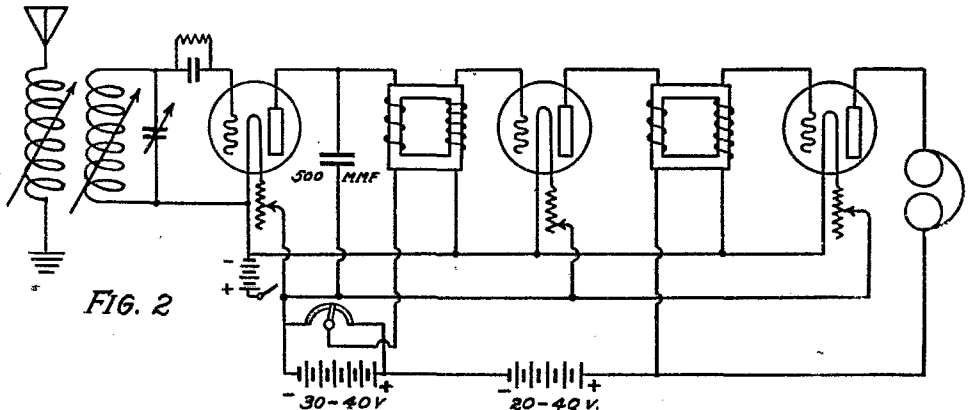

FIG. 2

waves. Impedance repeating is better and two-winding transformers best of all. The latter make possible a judicious choosing of input and output impedances to suit the tube characteristics, but more important is the fact that, as the tube is a potential-operated device, amplification comparing favorably with that of the tube can be obtained in the transformer itself by the use of a step-up ratio. This naturally depends on the tubes and should not be so great that the variation in grid voltage causes the changing plate current to reach either bend in its characteristic curve, or distortion and blocking will result, and particularly is this likely in the last stages of a multi-stage amplifier. It might be well, therefore, to employ a reduced turns-ratio for the extra steps; For example, a 1-to-4 ratio for the first tube, and a 1-to-2 ratio in the others. Obviously, however, we aren't likely to be bothered by blocking when amplifying very

with which excellent work has been done. This transformer has a core of outside dimensions 1 3/8" by 2 1/2", built up 3/8" square with well-shellaced iron laminations. Primary and secondary are wound on the same leg, secondary over the primary. Primary has 7,000 turns of No. 38 enameled wire, and the secondary 10,000 turns of the same, each layer being separated by a strip of oiled paper 2 mils thick.

There seems to be little to choose between the AudioTron and the Class I Marconi tubes in sensitivity as a detector. Both contain a small amount of residual gas and both therefore require adjustable A and B batteries for best results. The higher vacuum tubes, such as the Class II Marconi, are preferable as amplifiers; such a tube does not require adjustable batteries but functions better on the higher ranges of plate potential, say about 60 volts. In response to numerous inquiries we show in

(Concluded on page 17)

## Getting Your Licenses

**H**AVE you got your licenses so you can start operating? If you haven't, here's what to do and how to do it:

First, an operator's license, without which you cannot operate a station. If you have an unexpired commercial operator's license, you are fixed, but otherwise you'll have to be re-examined, as all pre-war amateur licenses have expired. We strongly urge that if at all possible you secure an appointment with your district Radio Inspector and report in person for the examination, so as to secure a first-grade amateur license. Provision is made, as in the past, to issue second-grade licenses to amateurs remote from the Inspector, but those within fifty miles are expected to apply for a personal examination; and, besides, there is much more satisfaction in having a "first", to say nothing of saving the delay in its receipt. In "cramming" for the quiz, we want to tip you off to something. Before the war the Department used to prefer brief, direct answers to the questions, but that policy has been changed and now they go on the theory that "what you fail to say you don't know"; so be prepared to answer questions explicitly and at sufficient length to show that you know all about it.

Then the station license, for which you are qualified to apply as a licensed operator. Ask your Inspector for forms. These application blanks call for description of various technical features of your set, from which the Department of Commerce ascertains whether it complies with the law in certain respects. Another tip: be very certain that you don't make the mistake of showing dimensions for your proposed antenna which will total more than 120 feet for the sum total of flat-top length, vertical portion, lead-in, and ground-lead to point of actual contact with the ground, or right on the face of things your set can't comply with the law and your request for a license will be denied. (If you can't report in person for the operator's examination and have to write for forms for second-class operator's license, ask at the same time for station license application blanks, and send both back together.)

Unfortunately, just at this time the Department is very short of clerical help in their various offices, and this is likely to cause delay in issuing station licenses. The Radio Inspectors are authorized, however, to advise applicants what call letters they will eventually receive on their licenses and authorize them to com-

mence operation at once, using their official call, without awaiting receipt of the actual license. It is imperative, however, that you have either the actual license or due authority from the Inspector to operate pending its receipt. We don't want any unauthorized transmitting using initials for a sig, etc.

Familiarity with the radio laws is required before an operator's license can be secured. The information is contained in a publication entitled "Radio Communication Laws of the United States", including all the regulations under which the Department of Commerce's Radio Service operates, and also the London Convention, etc. If you haven't a copy, send 15 cents by postal or express money order (stamps will not be accepted) to the Superintendent of Documents, Government Printing Office, Washington, and acquaint yourself with the regulations.

The Department of Commerce's list of ship and commercial "Radio Stations of the United States," edition of June 15, 1919, can now also be procured from the Superintendent of Documents, at 10 cents a copy. Naturally no amateur calls are in this edition, tho they will be in the next. Meanwhile QST will publish them. Drop us a line just as soon as you find out what your call letters are, so all of us will know whom we're hearing.

### QST First District Amateurs

Radio Inspector Gawler advises us of the following rules for applicants in this district. All amateurs within 40 miles of Boston must appear in person at the Custom House there for examination for first grade amateur license, on any Saturday, which day is given over to examinations for this grade. Out-of-town applicants for such examination will be considered on other days, but Saturdays are preferred. Blanks for this grade can be obtained only at Custom House—do not ask for them by mail. Holders of expired amateur licenses will have their choice of taking 12 words per minute with the written examination waived, or 10 words per minute and the regular examination.

Amateurs outside the 40-mile zone around Boston can obtain examination by writing the Radio Inspector for blanks for second grade amateur license, also requesting station license blanks at the same time. Examinations for this grade are conducted by mail, and if successful, licenses will be mailed and call letters assigned promptly.



## AT LAST!

Just as we were ready to mail last month's issue, the word came from Washington that the Navy Department had cut the ropes and removed restrictions on amateur transmitting. After throwing everything within reach at the office boy, and finishing off by jamming the waste basket down over his head, we grabbed the telephone and told the printer for the love of Mike to make room for an emergency sheet to go into every QST, and that we would pound something out immediately and be over in ten minutes. Talk about Impulse Excitation! We were both impulsive and excited. It seemed like the coming true of a dream. To realize that we could call up and holler QRT and QRM and do all of the other things that we had been longing to do since April, 1917, made it difficult to focus properly.

The far reaching effect of the removal of the ban on transmitting cannot be estimated. Probably every amateur in the country got as excited as we did here in the editorial sanctum. Maybe they didn't throw things, but if they were real dyed-in-the-wool, blown-in-the-glass, all wool and a yard wide radio bugs, they wanted to. These amateurs are going to make the removal of the ban on receiving look like a half-inch spark coil that has been rained on. Receiving is all right, but it is not to

be compared with receiving and transmitting. It is the transmitting that makes amateur radio what it is. The removal of the restrictions is going to be felt in every line of business from the lumber yard to the instrument maker. The Old Man's electrical supply store will have to order soldering paste by the barrel and the hardware stores are going to note a marked increase in the demand for everything from nails to copper wire.

But there is another side to this fair picture. A lot of us are going to find that some pet scheme is not going to work any where nearly as perfectly as we expected it would. Instead of radiating five amperes, it is going to be three-quarters of an ampere, or the tone is going to be ragged or the coupling has got to be looser, or the insulation about five times better. We are not going to have the air chock full of QRM right off quick. It is going to take time to get back, and a terrible lot of good hard work. But that is where we amateurs shine. All of the troubles will be gradually fixed up and transmitting distances that we never dreamed of are going to be matters of every day occurrence. The days of real sport are at last with us. Come on, fellows, and get into the air again.

## Q R M

On your life, don't cause interference with commercial or government stations! Reopening wasn't won easily, and we

believe the chief obstacles which delayed it were twofold; a mistaken supposition that all amateur activity was a kind of

child's play, withal interesting but lacking in practical value or serious moment, and second and far more important, that the amateurs were likely to interfere with commercials or government business. We all know that an amateur station complying with the law as regards wavelength and decrement can not interfere on the higher wave lengths and this we have ever lustily maintained. But now that we are open, the powers that be have an extremely watchful eye in our direction, and we are absolutely on our merits. If we interfere, we play right into the hands of the Navy Department and give them the strongest argument against us which could be devised.

Let all of us be continually on our guard that this does not happen. Do not take a chance—know what your wavelength is, make sure it is not over 200 meters, and comply with the law. Help the Junior Operators in your neighborhood to have law-abiding stations, by counseling them in the erection of their antenna and the tuning of their sets. In particular watch the decrement! If your coupling is too tight, you are breeding a mess of trouble for all of us, and here's why: Altho your circuits may be carefully tuned to 200 meters, too close coupling causes the radiation of two tunes, one less than 200 (and inconsequential) but the other above 200, and just how much above you do not know without a wavemeter. It may be 300, it may be 450, it may be 600 and smack on the commercial tune, and if so it will surely cause interference. Not only that, but in such a case the tune is inevitably very broad and the signals cannot be tuned out. Trouble for all of us is sure to result, and the good name of amateur radio will suffer. Remember that the only satisfactory way to tune a set is with a wavemeter, first

tuning the circuits to resonance and then employing the wavemeter in what is far more important—the determination of the proper coupling, not so loose that energy transfer is hopelessly inefficient but just at that nice degree where the two "humps" merge into one. Then there can be no trouble.

Let this thing get home to you, fellows. We make or break ourselves now. It is the actions of the individual operator which, summed up, make the whole of us—constitute the amateur field. If only every operator will do his part we will be jake. The standard of amateur knowledge has soared like the aviation altitude record since the pre-war days, and we should be heartily ashamed of a station that interferes, either due to the character of its emission or on account of the perversity of its operator. Let each and every loyal A.R.R.L. man constitute himself a Deputy Inspector. Keep out an eye and an ear to the activities in your neighborhood, and do your utmost to keep things up to snuff, wherever they come under your observation. If a station in your vicinity emits an unlawful wave and the operator is deaf to your admonitions to correct it, we counsel reporting him immediately to the Radio Inspector. Don't get the idea that this is "snitching." There can be no possible defense—not one shred of protection—for the amateur station which refuses to comply with the law, and we are all likely to find ourselves in trouble if these operators cannot be made to see the light of reason. So appoint yourself a Deputy Inspector to act for the good of all amateur radio—but be reasonable!

And on your life, don't cause interference with commercial or government stations.

## OH WHERE, OH WHERE?

In the August "Wireless World", published in England, appears a short article on the British amateur situation in which the writer expresses grave fears that if the British amateurs are reopened their desire to use audion detectors will cause wholesale

interference of a brand-new, startling and distressing type. "The thought of fifty valves, all oscillating unknown to their owners, howling in fifty different sharps and flats, all less than five miles from a wireless telephone station or a research



laboratory, is disturbing enough", apparently, to almost make the author "put 200 v. on the grid."

Just exactly where that advanced knowledge comes from we aren't able to puzzle out. We can't find a thing about it in our treasure-house. In fact, we rather get the impression that the gentleman isn't altogether in favor of seeing the restrictions on the British amateur removed, deep down in his heart. Perhaps that accounts for a rather extraordinary ability in the finesse of deprecation, otherwise "crepe-hanging."

Oh Mister Man, tell us how an amateur, Britisher or anybody else, can hope to receive spark signals on a tube, and preserve the musical characteristics, if he has it oscillating. And we're almost sure we've read somewhere that audible notes are produced only when oscillations of two impinging frequencies differ by such a value that the resulting beat frequency is within the

range of audibility, so that we can't quite see how interference would be caused by the radiation of the most ungentlemanly-oscillating detector tube of a British short-waver beating on the oscillations of a government station in all probability tuned to several times the wave length of the amateur. Or perhaps they have operators over there with radio-frequency ears. And we can't quite gather how the gentleman expects to receive telephonic speech on an oscillating tube; oscillating, for otherwise we aren't inclined to believe he'd have a beat frequency in his receiver. Or, tell us, Oh Seer, maybe in England two ham sets can beat on each other and produce an audible howl and the audio-frequency will be propagated five miles and give you QRM on a commercial wavelength. Honest, you have us there—we didn't know it could be done.

## **SPECIAL LICENSES**

The subject of special licenses is again in the minds of many of us, and no doubt the Department of Commerce is being deluged with applications of this nature, no appreciable percent of which can be granted.

Just how ought we to regard the issuing of special licenses? Should we all rush in and promiscuously ask for a special? That amounts almost to changing the standard amateur wavelength from 200 meters to 425. Isn't it a fact, tho, that the holding of a special license has been the ambition of many an amateur? And just exactly why? We doubt if the average amateur can put up a logical argument why he should be entitled to the privileges of a special license. Wouldn't it be well for us to talk this thing over among ourselves and decide what we think the purpose of a special is, and under what circumstances it should be issued? Discussion always brings out the kernel in such topics, and so we're willing to start the ball rolling.

The first question is, is there any advantage in possessing the privileges granted by a special license? As we see it, there is; not because the wavelength is different but

because for 425 meters a condenser can be used of so much larger dimensions that increased power can be utilized, and that is an advantage. The limitation of general amateur stations to a transformer input "not exceeding 1 k.w." is ludicrous for 200 meters, because the wavelength requirements so restrict the size of the condenser of such a set that it is impossible to utilize over 700 watts with an efficient transformer, using anything like ordinary secondary voltages. So we conclude the special license does have its advantages.

On the other hand we must remember that it is provided for use only in exceptional circumstances, and that brings us to the next point, which is "Who by rights ought to have special licenses?" We see several things: Very good work can without question be done on 200 meters, so that it is proper that 425 meters be reserved for exceptional cases. East of the Mississippi River stations are so thick that the exigencies of relay work and the demands of ordinary amateur experimentation do not call for it, and the congestion is such that extra power causes disproportionate interference. The farther east we

consider the more emphasized this condition becomes, and in particular along the North Atlantic Seaboard and also the California Coast we can see no logical reason for the issuance of any quantity of special licenses, as stations are thicker, relaying easier, interference possibilities worse, and especially inane is the risk we take in interfering with ship-to-shore work if specials are issued wholesale in this part of the country. There is very decidedly a place for them, however, and that is in the territory west of the Mississippi where stations are few and far between in a land of "superb distances." Relay work has been difficult thru this country just because of these facts, and it is notable that what work was done was possible only because of the fortuitous location of a small handful of excellent stations at strategic points, and certainly in these circumstances any-

thing which will in any wise improve operating ranges is extremely desirable. And right there is the secret of the whole thing: It is for exactly such work that special licenses are provided, and it is our humble opinion that their issuance ought to be restricted to cases of this nature where the spans to be covered make it necessary if successful work is to be done, and where the possibilities of interference are minimized.

We have been assured that discrimination is to be employed in the issuing of post-war special licenses, and if there is any logic in the foregoing paragraphs wouldn't it be well for us to take note of the handwriting on the wall and adjust ourselves to it by preparing to forego applications for specials whenever all the necessary work can be done on 200 meters?

## THE SINEWS OF PEACE

The psycho-theologists tell us that Heaven is a state of consciousness. That being so, every real amateur these days should be browsing around the 'steenth Plane in a state of wholly joyful bliss. Howzat? Just consider the wonderful array of splendid amateur apparatus which greets our reopening. Everything that we can think of is available, and all the practical developments of the art during the Great War have been embodied in the amateur lines presented for our selection at this time. The energies of large corporations who built up organizations of personnel and machinery for grinding out war contracts for government radio apparatus have in many cases now been diverted to the production of equipment for us; during the period of our inactivity the old-timers were busily engaged in keeping up with improvements and embodying them in the new lines which they should present when better days appeared on the horizon; so that now the Dawn of the New Day in Amateur Radio reveals a perfectly dazzling array of apparatus, past our dreams and so far removed from the stage in which the declaration of war found us that there is no comparison.

You've been feeling much this same way, haven't you? So that we don't have to say much about it to bring to mind that we are better equipped than ever before to do startling things in the field of amateur operating. More and more every day we see the limitations of intelligence of whoever attempts to prophesy what we will be able to do this coming winter or what we won't. We don't even dare to say that the sky's the limit for us.

Ever stop and think how apparatus is bound to sell now? We are on the verge of a most tremendous boom in the sale of equipment, for the pent-up schemes of all the hundreds of thousands of station owners are set free by our reopening and we know that the business of buying money orders to pay for instruments is going to give Mr. Burlesque's Post Office Department a lot of QRN. We are heartily glad to see our manufacturers coming into their own, for they are deserving of every good thing at our hands, and they've been mighty faithful to our QST. But murder! isn't apparatus going to sell like icicles in Hades; and don't we know some mail-openers who are going to have headaches! Get on to this new apparatus on the flood

tide, for you need it in your business. Write for the catalogs and then prepare your station for the busy season that is ahead of us.

Which brings to mind another little memory-jog, fellows: Whatever you do, don't forget to mention QST. We comprise the great buying public, and the manufacturers and dealers like to know just what moves us to write them. And it helps our QST immensely, for you know our advertising depends on the results QST

produces and we must feel it a solemn duty never to overlook giving QST the credit when we write our advertisers. The more results QST gives them the more our advertising will increase, and that's where the money comes from that produces QST. By never failing in this respect we will soon climb up to where we can afford a 132-page QST (visions of joy!) and even that isn't the limit of the ambition of us here at headquarters, by a darned sight.

## Calibrating Your Wavemeter

**T**HE Radio Laboratory of the Bureau of Standards is equipped to calibrate and test radio instruments of various kinds, charging a nominal fee. The particular feature which interests us is the opportunity afforded to get our home-made wavemeters accurately and inexpensively calibrated.

For precision wavemeters a charge of 50 cents is made for each point taken in the calibration, with a minimum of \$2.50 for each coil, as many readings being taken as desired, and of course the more the points the greater the accuracy. A reduced fee, however, is provided for amateurs, and in the case of wavemeters not suited for precision measurements submitted under the above-mentioned schedule the Bureau will charge a minimum fee of one dollar per coil. Enough points will be measured to give a calibration curve consistent with the optimum accuracy of the instrument.

Another facility which interests us is the taking of curves on tubes, and the Bureau is prepared to do any class of work in this line. The fee for taking the first characteristic curve of a receiving tube is \$4.00, and \$2.00 for each additional curve on the same tube. Amplification constants and internal resistances of receiving tubes will be measured for a fee of \$2.00 for the first determination, with \$1.00 charge for each additional determination on the same tube, etc.

Apparatus submitted to the Bureau for testing should be provided with identification marks, and shipped prepaid to Bureau of Standards, Washington, D. C., accompanied by a written request for the test, enumerating the articles, stating their identification marks, and setting forth explicitly the nature of the test desired. It is desirable that the conditions under

which the apparatus is used be stated, and in the case of precision wavemeters the number of points on the scale at which the apparatus is to be tested. Fees should accompany the apparatus, and remittance should be by money order drawn to the order of "Bureau of Standards." If yours is a precision wavemeter which you want carefully calibrated at a number of points at the rate of 50 cents per point, make reference to Schedule (D) (a). The authority for the special reduced fee for amateur wavemeters is Paragraph (7) on page 2 of their Testing Schedule No. 90, and applications for work under this provision should make due reference to this paragraph in order to avoid confusion.

### Some Dope on Hook-Ups

(Concluded from page 11)

Fig. 2 a circuit for the use of a detector and two stages of amplification with transformer repeating, operating off common A and B batteries, designed for potentiometer control of the plate voltage of the detector (which should not be an excessively-high vacuum tube), and providing for increased potential on the plates of the amplifiers (which should be high vacuum).

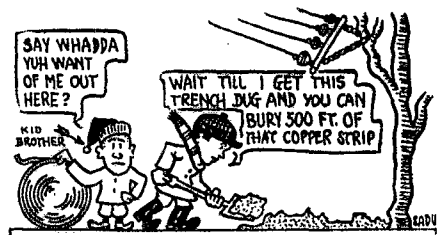

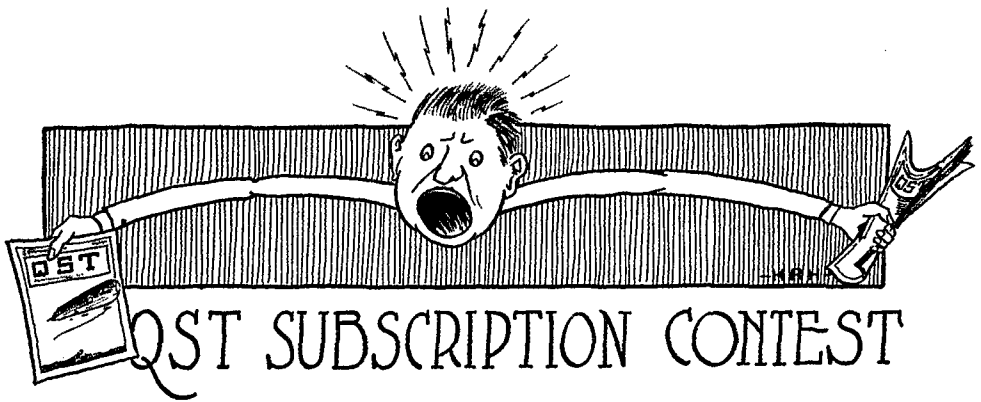

## QST SUBSCRIPTION CONTEST

Here is what you have been waiting for. To many of the most enthusiastic amateurs, first-class apparatus is out of reach financially. With the idea of helping these amateurs, who may become leading relayers, QST offers a proposition whereby instruments of the very highest type may be earned by a little work at getting subscriptions. QST subscriptions may be had for the asking. Try it and see.

In our former contests we had definite prizes, announced beforehand, and while the prizes were all apparatus of unquestioned quality it had the bad feature that a contestant might win a rotary gap when he already owned one and would much rather have a hot wire ammeter listed as a prize lower down in the list. So in this contest we've thought of a better idea. We're not going to specify any definite apparatus, but instead the prizes are money values which we will invest for you in any apparatus you may choose from the catalogs of any of the manufacturers listed. For instance:

The contestant who sends in the largest number of subscriptions before February 10, 1920 wins the First Prize of \$50.00 worth of apparatus. We will purchase for him any apparatus he may desire, up to a total of \$50.00 catalog value, from any of the manufacturers listed. Or, if he desires some special piece of equipment listed in excess of \$50.00, we will purchase that for him if he will send us a remittance to cover the difference.

For the one who sends in the second highest number of subscriptions, we will purchase \$30.00 worth of apparatus, whatever he

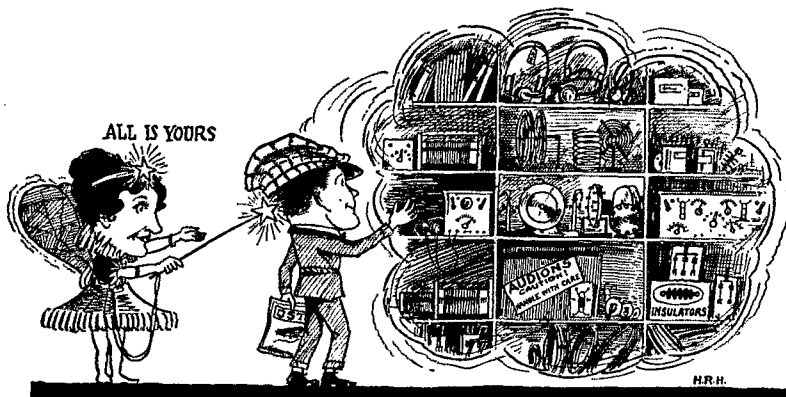

WHAT YOU'VE DREAMED FOR: YOUR RICK OF THE BEST AMATEUR APPARATUS IN AMERICA

may select, from the catalogs of any of these manufacturers, or allow credit for that amount in the purchase of more expensive apparatus.

The third, fourth, and so on up to the twentieth, receive the amounts listed below. Look it over.

The conditions are not complicated. They are simply:—

1. Send in your name and address and we will send you some subscription blanks. To be entered in the contest, your subscriptions must be sent in on these blanks. Be sure to write your OWN name on the back of each blank so that we may know whom to give credit.

2. To be entitled to any of the first ten prizes, you must send in a minimum of 15 yearly subscriptions or their equal. To be entitled to any of the last ten prizes, you must send in a minimum of 10 yearly subscriptions or their equal.

3. Any one is eligible, whether a subscriber or not.

4. Twelve credits are given for each yearly subscription. Short term subscriptions are counted in proportion. Extensions of existing subscriptions and renewals count the same as new subscriptions. Special discount coupons not accepted in this contest.

5. All subscriptions must be in this office before midnight February 10, 1920. If received later, they will not be credited.

Scores will be printed monthly in QST so that you will know how you stand compared with the other entries. We will be pleased to tell you your score at any time by mail, send you more blanks, or help you in any manner possible.

Remember that you're actually doing folks a favor when you induce them to subscribe to our QST. QST is 100 per-cent amateur radio, and is the only genuine monthly joy-bringer "of, by, and for the amateur." Subscriptions will sell like hot-cakes. All you have to do to sell a "bug" is to shake a QST in his face and show him where to sign. Another thing which will help you is that there actually exist

a lot of former readers whom we haven't been able to tell the good news that QST has reappeared, and the least intimation of your purpose should bring forth their little old one-fifty, pronto. But don't content yourself with the amateurs in your own town alone. Write all the fellows you know, for it's subscriptions that count for you. Don't forget that the most unexpected folks are often good prospects,



DON'T MISS LINING UP EVERYBODY AT THE CLUB

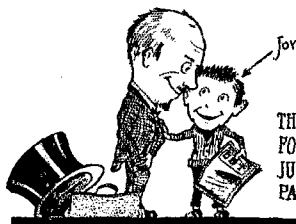

THE MOST UNEXPECTED  
FOLKS ARE PROSPECTS  
JUST F' RINSTANCE THE  
FAMILY DOCTOR

just itching to hitch up with a good amateur magazine—which means us. Your best girl's brother's second cousin may be interested, and you don't want to miss any bets. Everybody starts out with an equal chance, but the hardest workers will be the winners. Are you on?

## BEST AMATEUR APPARATUS IN AMERICA --- FREE !

Here are the prizes. Prices for good apparatus naturally are higher than before the war, and now is your chance to have what you need handed to you free. Just scan this list and think what it will buy for you. Regenerative sets, amplifiers, head-sets, variometers, condensers, detectors, V. T's., storage batteries, loose-couplers, transformers, rotary gaps, meters, switches—just exactly whatever it is that you most need to equip your station.

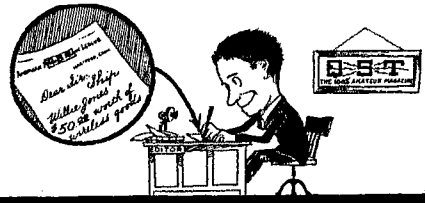

MAKE IT BE YOUR NAME THAT THE EDITOR PUTS ON THIS ORDER.

THE PRIZES						
1st Prize,	\$50.00	worth	of	apparatus,	catalog	prices.
2nd	30.00	"	"	"	"	"
3rd	25.00	"	"	"	"	"
4th	22.00	"	"	"	"	"
5th	18.00	"	"	"	"	"
6th	15.00	"	"	"	"	"
7th	12.00	"	"	"	"	"
8th	10.00	"	"	"	"	"
9th	8.00	"	"	"	"	"
10th	7.00	"	"	"	"	"
11th	6.00	"	"	"	"	"
12th	6.00	"	"	"	"	"
13th	6.00	"	"	"	"	"
14th	6.00	"	"	"	"	"
15th	5.00	"	"	"	"	"
16th	4.00	"	"	"	"	"
17th	3.00	"	"	"	"	"
18th	3.00	"	"	"	"	"
19th	3.00	"	"	"	"	"
20th	3.00	"	"	"	"	"

And here is the list of manufacturers from whose catalogs you may select your prizes, choosing exactly what you wish from any number of firms. All you have to do is to send us a list of what you want, giving



OODLES OF CATALOGS FROM WHICH TO CHOOSE

the manufacturers' catalog numbers, and will have the apparatus shipped you direct. You can't go wrong on any of this equipment. The firms are the best in the art and their products are recognized as a standard. If you haven't their catalogs, write for them. These manufacturers make

---

## The Best Amateur Apparatus In America

---

Acme Apparatus Co.,	Cambridge, Mass.
Arnold, J. F.,	New York City
American Radio & Research Corpn.,	New York City
Barr Mercury-Cup Detector,	Washington, D. C.
Brandes, Inc., C.,	New York City
Bunnell & Co., J. H.	New York City
Burgess Battery Co.,	Chicago
Chicago Radio Laboratory,	Chicago
Clapp-Eastham Co.,	Cambridge, Mass.
Connecticut Tel. & Elec. Co.,	Meriden, Conn.
DeForest Radio Tel. & Tel. Co.,	New York City
Firth & Co., Inc., John,	New York City
General Radio Co.,	Cambridge, Mass.
Grebe & Co., A. H.,	Richmond Hill, L. I.
Marconi Wireless Tel. Co.,	New York City
Murdock Co., Wm. J.,	Chelsea, Mass.
North American Aerial Spar Mfg. Co.,	Dubuque, Iowa.
Radio Distributing Co.,	Brooklyn, N. Y.
Radio Equipment Co.,	Philadelphia
Thordarson Elec. Mfg. Co.,	Chicago
Tresco,	Davenport, Iowa
Tuska Co., The C. D.,	Hartford, Conn.
Universal Radio Mfg. Co.,	Elmira, N. Y.
Watkins Manufacturing Co.,	Wichita, Kansas
Wireless Improvement Co.,	New York City
Wireless Specialty Apparatus Co.,	Boston

AND MORE NAMES TO FOLLOW NEXT MONTH

---

Address all communications to

**THE CONTEST MANAGER** American Radio Relay League  
Hartford, Conn.

# The Operating Department

J. O. Smith, Traffic Manager  
Rookville Centre, L. I.

**A**MATEUR radio has once more assumed its proper place in the activities of the day. It is a rather sad commentary on the state of things as they are, however when the League finds it necessary to pry off the lid by means of legislative action. The same powers—that be that refused to allow amateur transmitting now, until forced to do so by Congress, are the same powers—that be that welcomed the amateurs with open arms in the spring of 1917.

However, the fact that the lid has been lifted, that the might of one could not prevail against the right of many, makes every one of us feel glad that this is America and that we are Americans. Let us hope that the unwholesome spectre of autocracy has been banished forever from amateur radio, and that we may in future be assured of security against interference with our right to practice an art that hurts no man, but lastingly benefits many. Although the Country is dry, I have managed to fill a glass, and I now drink to the past, present and future of amateur radio—may it radiate and oscillate for ever and ever, without end.

The reports from the Division Managers this month are rather light. Possibly the sudden shock of the reopening was too much for them. However, it will probably be a question in a month or so as to what to do with all they have to say about the reopening of stations, forming of trunk lines, traffic, etc.

The attention of every member of the League is called to the fact that all amateur station licenses have expired and that new ones must be procured from the Radio Inspector. This was fully outlined in the Operating Department report in the September issue of QST.

The reports of the Division Managers follow:

## ATLANTIC DIVISION.

Chas. A. Service, Jr., Manager.

At last the great day has come when once again we can watch the ammeter needle run across the scale, hear the old familiar radio voices calling us, blink lights to our hearts content and do all the rest of those things so closely connected with the operation of a transmitting set. And this time, like the removal of the receiving ban, the news came but a short time previous to the order going into effect.

But where are all those stations who were supposed to be up and ready on their toes to start relay work and general amateur chewing again? This report, written after the first night of reopening, is based on the fact that the Division Manager and his new partner, 2AGJ, listened on the air till a ripe old hour last night and only heard five local amateurs and no long distance at all. Did anyone hear 3QZ? When this report is printed in QST no doubt the air will be filled with all sorts of sounds, as in the old days, but just at this time, when some of the old guard are straining their ears to hear something on 200 meters further away than ten miles, it is distinctly disappointing to hear such silence.

Reports of District Superintendents were sent in before they knew of the removal of amateur restrictions on transmitting and therefore still contain much of the same hopeful tone and tentative placing of relay stations and new lines, but that time is past and we are now face to face with the necessity of GETTING GOING just as fast as we know how. The time is at hand when the hazy relay lines which are founded largely on hope and faith will be put to the test; the official stations which have already been appointed to handle the work must be on the jump to prove they can deliver the goods, otherwise the Assistant Division Managers and Superintendents will get busy rearranging lines and finding new stations which can handle the work.

The months of October and November will, perhaps, be the most important for the official stations and relay work in general, as it will be during these months that definite relay routes will be established, both inter and intradivisional, and those stations which get to work right at the start, show pep and efficiency and willingness, will be those which stand out in the mind of the District Superintendents when they go over the list of stations which have shown they can handle Trunk Line relay work, in order to appoint them permanently. Therefore, this advice to those who have not already taken it; get in touch with your Superintendent, work all the time to make your set produce results, let other relay stations hear you're on the job to handle their business, and it will soon become known that you are promising material.



We are sorry to learn that our old calls won't be reassigned but there's a very good reason back of it and in view of the fact that it will probably take us only a few weeks to get on to the new ones, there's no use in lamenting.

The great work of the League, as shown by the fruit of their labor in Washington to bring action on the transmitting ban, can not be overestimated by amateurs today, who can be pretty certain that but for the efforts of the League, they would still be silent in ethereal circles. The value of concentrated action, of affiliation into one big League, of numbers to back up arguments, of a united front representing men and boys from every part of the United States, is demonstrated beyond a doubt in the results of the American Radio Relay League. The most potent argument to any man who doesn't know whether he will join the league or not, is to remind him of the fact that if many thought as he did, there would be no amateur transmitting today and perhaps not tomorrow or the next day. Think it over and you'll be proud of the organization to which you belong.

Next month's report will have definite relay routes as shown by reports from Assistant Division Managers and District Superintendents, which in turn will be based on actual results of relay stations. So get on deck, make yourself known to your Superintendent and you'll be one of those elected for a trunk line or branch route.

#### ATLANTIC DIVISION (Northern Section).

**Guy R. Entwistle, Ass't Division Manager,  
136 Sutherland Road, Brookline, Mass.**

Relay stations will be located at the following points in New Hampshire: Concord, Pennacook, Franklin, Tilton, Laconia, Ashland, Plymouth, and Warren. All good stations and can be depended on to handle relay work. There will be about 25 others, smaller but promising material, for feeders and distributors. Formation of a radio club is being undertaken. All radio enthusiasts in New Hampshire and especially around Laconia should get in touch with Dist. Supt. Henry R. McLean, 342 Union Ave.

We wish that more radio amateurs would get the spirit and join the great radio fraternity of relayers. No initiation fees, no expenses whatever, but excellent returns.

Local amateurs will be glad to know that 1LE, Harvard Wireless Club, will be back strong this Fall. Mr. Sumner B. Young writes that the old set, a quenched-gap 500 cycle  $\frac{1}{2}$  k.w., will be used.

The Technology Radio Club is again active after many weeks of vacation. Mr. Hamilton Maxim, son of the president of the A.R.R.L., is a member. Messrs. Henry Kurth and Fullerton Webster, local amateurs are actively associated.

A trip to Portland resulted in lining up a few live wires in that district. Mr. Earl G. Ham will look after things for us up there. They had a large radio club before the war. We hope they will soon get together again. Mr. Cassinau, who was stationed at Bar Harbor, should make an excellent leader.

Mr. Donald F. Alexander, of 209 Elm St., Bangor, has been appointed District Superintendent of Northern Maine.

District Superintendents Bates, of Worcester; Pulley, of Greater Boston; Hardy, Northern Mass.; and Bowen, Lower Mass. and Rhode Island, all report progress in their respective territories.

Wm. G. Walker, formerly IATR of Everett, was in from Vancouver, B. C., the other day. He reports much amateur activity in the Northwest. He is going to submit a Canadian Relay Chain to us, including several of the Canadian colleges that have high-powered sets. The Canadian Government seems to be taking advantage of the lesson learned by costly war-time experience and is encouraging amateur activities. The Canadian amateurs, it will be remembered, have a sliding scale of wave length instead of power as they approach commercial government stations. Fifty meters is all that is allowable within ten miles. It is remembered that the St. Lawrence is ice-bound in the winter months and commercial activity ceases, leaving the ether free for the amateurs, who can use most any power or wave length. This compensates for the smaller number of stations and should permit good co-operation between our chains and their's.

#### ATLANTIC DIVISION. (Southern Section)

**Chas H. Stewart, Ass't Division Manager,  
St. David's, Penna.**

In view of the fact that the prohibition against amateur transmitting is lifted, there is no doubt that within a short time, after the necessary formalities of obtaining licenses from the Department of Commerce are completed, there will be great activity. Our experience so far has been that there is only one real way to build up a successful relay system, and that is through the beginning of actual radio communication, supplemented by activity on the part of all the officers of the League. Until the present time it has been up-hill work to get many interested. It is now believed there will be a rapid change in the situation.

Mr W. T. Gravely, Supt. for the Central Virginia District, has been giving very ac-

tive consideration to the question of establishing the route to the South (Line D), and his efforts are greatly appreciated. He states that his station is in readiness to operate just as soon as he receives his licenses. He is hoping to have a good short range route between Danville, Va. and Washington, D. C., and he should receive the assistance of all stations in that territory to enable him to accomplish this as soon as possible.

No reports were received this month from Mr. Schaeffer, of Washington, D. C. or from Mr. Duvall, of Baltimore, and it is assumed that the absence of these reports was due to the fact that, no change having taken place in the situation, there was little if anything of interest to report. However, they will not have that excuse next month, and it is hoped that they will then be able to report much progress.

The Superintendent of the Eastern Pennsylvania District, Mr. E. R. McCaskey, reports that he is obtaining considerable information regarding prospective stations, in outlying districts. He is especially anxious to get into communication by letter with some good relay station in or near Lancaster, Pa. He has also located some prospective stations in Wilmington, Del., as this seems to be a very desirable link in Line D. (Bangor, Me. to Jacksonville, Fla.). Until the appointment later on of a District Superintendent for the State of Delaware, Mr. McCaskey is temporarily endeavoring to cover the territory in connection with his own District.

As stated in last month's report, the Central Pennsylvania District is temporarily in charge of Mr. Herbert M. Walleze, 234 Vine St., Milton, Pa., during the absence of Mr. Cawley, the Superintendent. He has communicated with State College, and feels sure they can be relied upon for satisfactory relay work. He seems to be optimistic as to the future after the ban on transmitting has been lifted. He is particularly anxious to get into communication by letter with good relay stations in Harrisburg or vicinity.

The main routes for the successful operation of a portion of which this section of the Atlantic District is responsible are as follows:

#### LINE "B"

Philadelphia to San Francisco, Cal. via Pittsburg, Pa, Columbus, O., Indianapolis, Ind., St. Louis, Mo., Kansas City, Mo., Denver, Col., and Salt Lake, Utah (Central Route).

#### LINE "D"

Bangor, Me. to Jacksonville, Fla. (Atlantic Route).

The following tentative routes have been mapped out through this territory. The success of these routes is dependent upon securing reliable stations at the points

named, and they are in no sense to be considered as a final arrangement.

#### LINE "B" (Northern Penna. Route).

Beginning at Philadelphia, Pa. thence via Bala, Pa., St. David's Pa., Norristown, Pa., Pottstown, Pa., Reading, Pa., Pottsville, Pa., Sunbury, Pa., Milton, Pa., State College, Pa., Curwensville, Pa., Punxsutawney, Pa., Butler, Pa., Pittsburg, Pa., Beaver Falls, Pa., thence connecting with Ohio points via Columbus, Ohio.

#### LINE "B" (Southern Penna. & Md. Route).

From Philadelphia, Pa., Bala, Pa., St. David's, Pa., to Lancaster direct (or via the Northern Penna. Route to Lancaster) thence via Marietta, Pa., Harrisburg, Pa., York, Pa., Hanover, Pa., Gettysburg, Pa., Hagerstown, Md., Cumberland, Md., Uniontown, Pa., Monongahela, Pa., Washington, Pa., or Pittsburg, Pa., thence connecting with Ohio points via Columbus, Ohio.

#### LINE "D"

From Trenton, N. J. via Bristol, Pa., Philadelphia, Pa., Chester, Pa., Wilmington, Del., Elkton, Md., Belair, Md., Baltimore, Md., Washington, D. C., Alexandria, Va., Fredericksburg, Va., Richmond, Va., Lynchburg, Va., Danville, Va., thence connecting with the East Gulf Division.

LINE "D" (Alternate route Philadelphia to Baltimore).

From Philadelphia, Pa. via Line "B" (Southern Penna. Route) to Hagerstown, Md. thence to Frederick, Md. and Baltimore, Md.

#### BRANCH LINE No. 1.

Philadelphia, Pa., Bala, Pa. or St. David's, Pa., Norristown, Pa., Emaus, Pa., Allentown, Pa., Leighton, Pa. or Bethlehem, Pa., Wilkes Barre, Pa., Scranton, Pa., Susquehanna, Pa. or Sayre, Pa., thence to Central New York points.

#### BRANCH LINE No. 2.

Pittsburg, Pa. to Erie, Pa. via Pittsburg, Pa., Butler, Pa., Grove City, Pa., Meadville, Pa., Cambridge Springs, Pa., Edinboro, Pa., Sterrittania, Pa., Erie, Pa., thence to New York points connecting with Line "A" (New York to Seattle, Wash.)

The above lines are based upon a survey of locations of stations prior to the war, and it is hoped that the owners of any stations who feel they can assist in bettering these routes will promptly communicate with me, giving the locations of stations with whom they believe they can communicate.

I would also like to hear directly from the owners of stations at any of the points above mentioned, with an expression of opinion as to whether they can be depended upon for relay work, or not. In this way only can the proposed routes be put upon a working basis. Any stations that will prove of value will be added to the routes

as soon as they are known to me. The Assistant Division Manager hopes that he will have the hearty support of everyone in his District in endeavoring to arrange for the routes.

### ROCKY MOUNTAIN DIVISION.

M. S. Andelin, Manager.

120 Canyon Road, Salt Lake City, Utah.

Mr. Ira Kaar, 243 7th South St., Salt Lake City, has been appointed Assistant to the Division Manager.

No other appointments have been made, altho we need another Superintendent in Colorado and some good men in Idaho, Montana and Wyoming, practically no response having been made by amateurs in those states. You fellows who want to get in on the relay stuff must get busy now. If you don't you will probably get left, because we intend to have all appointments for official stations made quickly.

We have a condition in this Division probably unlike those in any other division. The amateur population is very scarce. Long jumps in relaying will be necessary. Most of the transcontinental relay traffic will probably have to go via Trunk Line B and to insure proper communication at all times we will have a number of standby stations thruout the central part of this division from the north to the south, so the station having the best conditions may take the work. According to my observations the conditions vary considerably and they will all be kept busy. Static and fading signals are two common troubles here.

I want to organize branch lines in Montana, Idaho and Wyoming, but unless we hear from new members we will have to leave the arrangements until we resume transmitting and are able to find stations that can do the work.

Mr. Beedle, of Reno, Nev., reports he will be with us soon. This station will fill in the gap between Salt Lake City and the Coast. Mr. Kaar reports a new station being erected in Bountiful, Utah.

### WEST GULF DIVISION,

F. M. Corlett, Manager,

1101 East Eighth Street, Dallas, Texas.

Since the last monthly report of this division only one appointment has been made. Mr. Bennett Emerson, 3730 Wendelkin Street, Dallas, Texas, has been appointed District Superintendent of Northern Texas. All communications pertaining to Northern Texas District should be addressed to him. Mr. Emerson will begin the organization of an efficient traffic force for his district immediately and all amateurs are urged to communicate with him at once so that he can best determine the men suitable for Asst. Dist. Supts. and also make selections of stations for trunk lines.

The District Superintendent of Southern Texas and the Division Manager have been counting on Beaumont, Texas, to fill a gap between Houston, Texas and the Eastern boundary of the West Gulf Division where it joins the East Gulf Division but so far it seems that our efforts have been in vain. It is hoped that Beaumont will yet come forward with a good station capable of filling this gap, which is also a gap in Line "C" Jacksonville, Fla., to Los Angeles, Calif. It may be necessary to locate this route further North, possibly connecting with the East Gulf Division via the Northern Texas District.

The Division Manager is still desirous of hearing from men located in Oklahoma and Arizona Districts who would be willing to act as District Superintendents of those Districts.

James L. Autry, Jr., Dist. Supt. Southern Texas Dist., 5 Courtlandt Pl., Houston, reports plans under way for a Club in every city in his district except Beaumont, which place seems utterly lacking as to radio.

On Sept. 18th a meeting was called of all the radio men in the City of Houston and a club was started with an initial membership of thirty. The Club is known as The Houston Radio Club and will within the next month make application for affiliation with The American Radio Relay League. There are under construction in the City over ten stations which hope to do long distance relay work for the A.R.R.L.

Mr. W. H. Tilley, Asst. Dist. Supt. of Austin, Texas Territory reports that the club there is progressing nicely and is making immediate application for affiliation. There are over four high powered stations under construction in Austin. The Lone Star Capitol can depend upon radio connection.

### PACIFIC DIVISION.

Seefred Brothers, Managers,

343 So. Fremont Ave., Los Angeles, Calif.

The list of relay men who are expected to be on duty when the ban is lifted, are given below:

F. G. Beck  
L. A. Bartholomew  
L. Dillon  
J. F. Hopkinson  
C. H. Keller  
A. A. Kluge  
H. St. J. McIntosh  
Seefred Bros.  
C. W. Tilden  
F. Van Why

### PACIFIC DIVISION,

F. Terman, Ass't Div. Manager,  
Northern California.

The following is the list of tentative relay stations for the district of Northern California which are expected to assist in relay work:

San Francisco	6SH
Oakland	6AC
Alameda	6AHN
Stanford and Palo Alto	6AG, 6FK, 6FT
San Jose	6AU
Monterey	6GC
Walnut Grove	6KU
Lodi	JS
Sacramento	6RA, 6PN

This list covers almost all of the possibilities among the old relay men, as these are the only ones heard from who are planning to start up out of the former long distance stations. With a few exceptions the new relay stations, excluding those above mentioned, must come from the ranks of the new amateurs.

In order to facilitate the accurate and

quick transmission of messages, I would suggest that the manager send out instructions to be distributed among the relay stations as to the proper preamble for all messages, how to count the words of a message, as numbers, initials, cable count, etc. (This will be fully covered in the next issue—Traffic Manager.)

L. E. O'Brien, 902 South G St., Apt. 34, Tacoma, Wash, District Supt. for Washington, sends out an SOS to complete Trunk Line A and build up Line F thru Washington. All amateurs considering relay work are urgently requested to communicate with him as soon as possible with a view to appointments. This invitation is extended to radio amateurs in British Columbia.

## Harmonics

**T**HE Editor has received a number of letters from readers inquiring for information of various kinds about harmonics, and the correspondence shows so many erroneous conceptions that it seems advisable to present a little information on the subject.

Eccles defines harmonics as follows: "In the natural oscillation of a circuit possessing distributed capacity and inductance, the harmonics are those component vibrations whose frequencies are integral multiples of the frequency of the fundamental. A harmonic is called even or odd, according to whether the multiplier is even or odd. . . . In electrical affairs the harmonic of double the frequency of the fundamental is. . . . called the second harmonic, and so on."

The next feature of interest is a well-known fact in the study of wave forms in electrical engineering: that if a complex wave is such that successive positive values of the ordinates for a positive half-wave are numerically equal to the successive negative values for the succeeding negative half-wave, only the odd harmonics occur. Such a wave is called symmetrical and therefore contain only the odd harmonics.

This will be better understood by reference to the figures. "A" represents the voltage and current distribution along a vertical wire antenna oscillating at its fundamental frequency, and it will be seen that the length of wire is equal to the distance from node to loop, or  $\frac{1}{4}$  of the wavelength. Such an antenna may oscillate with other current and voltage distributions, but the top must always be a node for current and the bottom a node for voltage. Thus in "B" is shown the next possible oscillation. Here the length of wire is  $\frac{3}{4}$  of a wavelength and hence the period is one-third of the fundamental, which is to say that the frequency is three

times as great. Other possible oscillations have frequencies five, seven, nine, etc. times the fundamental.

Terminology differs with various experimenters, some preferring to call the first harmonic one-third of the fundamental, the second harmonic one-fifth of the fundamental, etc., but in general in radio we may call the fundamental the first harmonic and say that a frequency three times

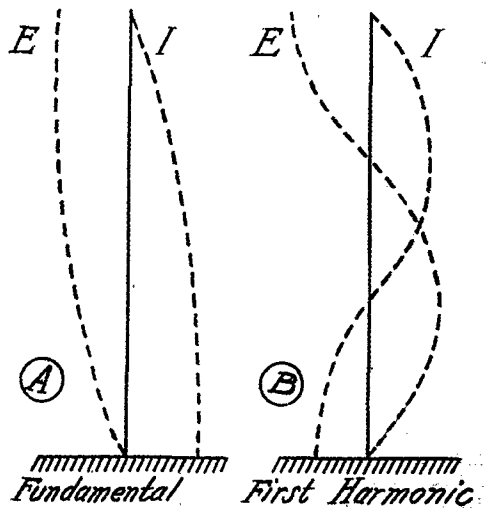

the fundamental is "the third harmonic", and so on.

Have you ever accidentally picked up an arc set when tuning at a wavelength under 600 meters? If so it was on a harmonic, and it is in this connection that a knowledge of harmonics is particularly interesting. The energy content of the overtones generally is quite small by comparison with the fundamental but interesting experimental

work may be done by tuning for the harmonics. Radiation from a high-frequency alternator generally does not contain many harmonics, but the arc stations are rich with them and arcs within a few hundred miles usually can be copied without the necessity of tuning up to their fundamental. If you know their wavelength, get the bulb oscillating and carefully search for them around the most convenient harmonic and generally success will reward your efforts. (It may here be said, in the nature of a caution, that for transoceanic work and the reception of optimum signals, stations should be carefully tuned in at the fundamental, and in letters received from readers complaining of weak arc signals we notice that frequently the constants of the circuits employed are such as to make reception of the fundamental impossible and obviously the reception has been on a harmonic.)

From the foregoing data it may be seen that the first tune on which we could get such signals is one-third of the fundamental, and so on. Certain stations can be copied on tunes that do not seem in accord with this theory, possibly due to strong re-radiation from guy-wires at some mixed

multiple, and government engineers are now making a study of the subject.

Experimental work is also being done in the direction of transmitting on harmonics, using an antenna circuit wavelength three or five times that of the closed circuit and obtaining creditable radiation on the over-tones—a feature which may have considerable interest for us on account of the desirability of having a long aerial for receiving purposes. This is possible only with arc transmitters, spark transmitters being comparatively free from harmonics. The same line of experimentation bids fair to overcome the difficulties of short wave transmission with arcs. It is well known that much difficulty attends attempts to produce stable oscillations with an arc at wavelengths much below 1000 meters, but successful sets are now being made wherein the antenna circuit is tuned to a harmonic of the closed circuit, with very fair over-all efficiency.

It is rather fortunate from the standpoint of our relay work that these features are confined almost entirely to arcs, or spark QRM would be multiplied as many times as there are harmonics.

## Notes on the Quenched Gap for Amateur Use

By H. J. Tyzzer

Engineering Dept., American Radio and Research Corpn.

**N**UMEROUS articles have been published on the development of radio during the war and it has been pointed out that perhaps no other art has taken such rapid strides toward perfection. A large part of the work was devoted to the study and improvement of vacuum tubes for both transmitting and receiving. As a result, tube amplifiers have been constructed which have increased the range of the receiving station many times. The tube transmitters, although very effective for local work, are limited in output and hence cannot be used to any great advantage for long distance transmission.

For this reason the Navy Department has deemed it advisable to adhere to the conventional 500 cycle quenched gap transmitters. Such an equipment has proven both effective and reliable and large quantities of standardized sets of this type have been manufactured during the war.

It would then seem advisable for the amateur who wishes to transmit long distances and still adhere to government restrictions to follow as closely as pos-

sible the path laid out by the Navy Department and experienced commercial companies. It is planned that this paper shall point out a method whereby this desirable objective may be attained.

It is assumed that the amateur has at his disposal a source of 60 cycle alternating current. With such a supply it is customary to employ a step-up transformer, a high potential condenser, some form of gap, and an oscillation transformer, together with such accessories as a key, protective devices, and radiation ammeter. However the power of the above equipment is limited because of the 200 meter wave restriction. With such a low wavelength it is practically impossible to employ a condenser of more than .01 or .012 Mfd. capacity and have allowance for inductance of leads and proper coupling. This means that a much higher voltage must be employed by the amateur than if a supply of higher frequency were available. Such a high voltage often leads to gap difficulties, condenser troubles and low efficiency. It used to be customary to employ a plain gap which ordinarily gave a note that was anything but pleasing on

60 cycles and which was noisy in operation. This gap also caused a wave having a very high decrement to be emitted from the transmitting antenna, which tuned broadly at the receiving station and caused a great deal of interference.

The introduction of the non-synchronous rotary gap into the amateur field marked a great improvement in transmitters in general inasmuch as a clear note with appreciably decreased decrement in the antenna circuit was obtained. Even with a rotary gap, however, the conditions are far from ideal as the efficiency is usually quite low and the decrement often exceeds the 0.2 allowed by government regulations. Or in other words, when the coupling is made sufficiently loose to bring the decrement below 0.2 the equipment is not operating with maximum radiation.

For this reason it has seemed advisable to investigate thoroughly the results obtained by using a quenched gap on a 60 cycle supply. These investigations were carried on in the laboratories of the American Radio and Research Corporation at Medford Hillside, Massachusetts, and the following data recorded which shows the advantages of the quenched gap.

Tests were first made with a  $\frac{1}{4}$  K. W. Blitzen transformer. This type transformer is resonated to a capacity of .01 Mfd. on 60 cycles. It was found impossible to work this transformer at its rated capacity with the leakage tongue which is inserted between the primary and secondary in place. Therefore the tongue was removed and resonance sacrificed for increased output. Three mica condensers of .004 Mfd. each were used totalling a .012 Mfd. capacity. The plain gap consisted of two centimeter brass balls, whereas the rotary was of the Murdock type, the quenched gap being manufactured for amateur use by the American Radio and Research Corporation.

A Murdock oscillation transformer was used with a phantom antenna consisting of a .00035 Mfd. capacity, a loading spiral and 10 ohms inserted resistance. The quenched gap was compared with both the rotary and plain gap referred to above and the following data obtained:

#### TEST NO. 1.

Total antenna resistance—15 ohms.

Gap	Input Watts	Wave- length	Watts in antenna	Efficiency
Plain	135	200	41	30.4%
Rotary	135	200	43.6	32.4%
Quenched	135	200	60	44.5%

#### TEST NO. 2.

Gap	Input Watts	Wave- length	Watts in antenna	Efficiency
Plain	250	200	78	29.2%
Rotary	250	200	82.5	33%
Quenched	250	200	94	37.5%

A  $\frac{1}{2}$  K. W. Blitzen transformer was then tried and 10 more ohms inserted in the antenna circuit thus totalling approximately 25 ohms and the readings below obtained:

#### TEST NO. 3

Gap	Input Watts	Wave- length	Watts in antenna	Efficiency
Plain	500	200	170	34%
Rotary	500	200	190	38%
Quenched	500	200	225	45%

From these readings it may be seen that a considerable increase in output was obtained (by the use of the quenched gap) and hence better overall efficiency. It was found possible, by selecting the proper number of individual gaps for a given power in the quenched gap unit, and by adjusting a variable reactance in the primary of the transformer, to obtain an exceedingly clear note of double frequency (120 cycles). This means a double discharge per alternation of the 60 cycle wave and gives a pleasing tone resembling that of a rotary gap running at low speed.

The transmitter was then connected to an L type antenna consisting of two wires 60 feet long and approximately 55 feet high. With 200 watts input the maximum antenna current obtainable with the rotary gap was 1.6 amperes. With this setting the decrement as determined with a Kolster decimeter was approximately 0.6. The coupling on the Murdock oscillation transformer was reduced until the primary and secondary coils were nearly at right angles. In this position the antenna current had dropped to 1.1 amperes and the decrement decreased to 0.2 (the maximum value permitted by government restrictions). It was found, however, that this 1.1 amperes at 0.2 decrement was far more effective than 1.6 amperes at 0.6 decrement. This was determined by observing the deflection of the wattmeter in the decimeter circuit, in both cases leaving the coupling conditions between the antenna and decimeter the same. We have all heard that the reading of an ammeter in the antenna circuit is an untrue indication of effectiveness with a plain or rotary gap and this is absolute proof of that fact.

The rotary was then replaced by the quenched gap and, with the same power input (200 watts), a radiation of 2.1 amperes was obtained. The decrement was only 0.12 which is well within the limit set by the government. Now then, note the comparison under these practical working conditions. With a 200 watt input 1.1 amperes radiation with the rotary and 2.1 amperes with the quenched gap, and, as the energy in the antenna is proportional to the square of the current this means a ratio of 1.21 to 4.41 or, in other

(Concluded on page 35)

## WHO'S WHO IN AMATEUR WIRELESS

We shall publish each month two pictures of amateurs who have become known to us in our work. This will draw us all closer together. We are often curious as to just what the other fellow looks like, and here's our chance to see.—Editor



**R. H. G. MATHEWS.**

Born at a very tender age on January 16, 1897 (Shhh!—by subtracting 1897 from 1919 we get 22.)

Got bit by the radio bug in 1909 while living in Springfield, Ohio. Moved to Chi in 1910 and inflicted an electrolytic interrupter and a 2" coil on the natives until 1912 under the alias of "RM" (Morse in those days).

Acquired the "long distance" habit in 1913 ("long distance" in those days meant 60 miles). In 1915 became notorious as 9IK and later achieved the distinction of 425 meters and blossomed forth as 9ZN and worked both coasts on 1 K.W., incidentally acting as Central Division Manager for the A.R.R.L. and taking an Electrical Engineering course on the side, and operating for the Marconi Company in the summers.

Smelled the war coming and enlisted in the Navy as Radio Gunner two weeks before the declaration. Tried to enroll



**F. H. SCHNELL.**

In resuming "Who's Who" we are pleased to present to our readers Mr. Fred H. Schnell, of Chicago. He is a well-known figure around Chicago amateur meetings but all of us are not so fortunate as to have met him.

His interest in radio dates from 1908 when he started to make an inch spark-coil but, deciding it was too small, started making a transformer, which suffered the same fate; then a 1 k.w. open core, but found even this didn't have enough power to increase his range much even when the window was open, so he discarded it and made a 2 k.w. This was back in 1911, in the days of unlimited power and wavelength, and the Chicago Wireless Association had him listed as a long distance amateur with a range of 20 miles. The law of 1912 scared him into getting a decent set, and the three-slide tuner and silicon went with the old transmitter.

In May, 1917, he enrolled in the Naval

**R. H. G. MATHEWS.**

everybody in the Navy with circular letters for a while and then served variously as Radio Censor at Grand Haven, Mich., and Benton Harbor, Mich., on the U.S.S. Yantic (often and correctly spelled "Antique"), in charge of the Great Lakes Radio Laboratory where Lieutenant Comdr. A. Hoyt Taylor conducted his famous experiments on underground antennae, as Officer in Charge of radio investigations in the 9th, 10th, and 11th Naval Districts Intelligence Dept., and finally as District Radio Material Inspector in the same districts, continuing at this to date.

Was recently pleasantly surprised at being elected Vice-President of the League and also appointed Central Division Manager.

Figuring on making more noise than ever before with a brand new transmitter, and in having lots of fun in using underground aeriels, eliminators, static preventers in profusion, probably to the everlasting ruination of all receiving results.

Favorite pursuits—arguing with M. B. West, 8AEZ, on rotary gaps, and preaching vociferously against the use of VT's as detectors, supplanting the old gas tubes.

**F. H. SCHNELL.**

Reserve as 3d class Electrician, Radio, and was successively promoted to 2d, 1st, and finally Chief, serving at Great Lakes, Belmar, and Washington Transatlantic Radio Control Office, and made three trips with the Presidential Party on the U.S.S. George Washington. His service is typical of the aid which successful amateurs were able to give the Navy, wholly as a result of amateur experience. While in uniform several incidents befell him which any radio man would cherish: While at Belmar he copied the first message from Rome (IDO) to President Wilson; copied the armistice acceptance message from Nauen (POZ) while at Washington; and his was the honor of transmitting to POZ the first message sent since our entrance into the war.

He is an ardent A.R.R.L. booster, and a regular whirlwind at organization, as his results in the Chicago District testify. One of our Vice President and Central Division Manager's right-hand men, he has most creditably acted as Chicago City Manager of the A.R.R.L. since our reorganization, but outgrew that job and is now Eastern section Assistant for Mr. Mathews—which ought to hold him for a while.

---

## ***U-Boat Radio***

*By J. A. Crowds*

**H**OW would some of you radio bugs like to find yourselves suddenly turned loose and free to do as you pleased in the radio shack of one of the late Kaiser's latest and largest sea-going U-boats? You'd have a heluva time wouldn't you? Well, that is exactly what happened to yours truly, for for three weeks I was solely in charge of such a radio shack and carried the key to same securely tucked away in my hip pocket. Here's how it happened. After the German subs had surrendered, a bunch of American submarine men attached to the flotilla then lying at Portland, England, were sent up to Harwich to man four of the U-boats. I was then, and had been for the past year, attached to one of the U. S. subs operating in European waters. When I was informed that I was one of those being sent to Harwich I was—well, like the small boy receiving his first wireless signal, just a bit excited. But to get down to the main part of my story—we reached Harwich in due time, and immediately went aboard and took over our four allotted boats. Of course the first thing I looked for on my boat was the radio shack, and after having missed it on the first trip thru the boat I found it on the second, securely tucked away in one

corner of the central compartment. Take it from me I lost no time in getting acquainted with the mysteries of the various pieces of apparatus. Of course all the directions, name plates etc. were in German, which, while helping to complicate matters somewhat made the work of exploration all the more interesting. And believe me I did SOME exploring. A lieutenant commander, erstwhile radio expert, walked in as I was looking over the station and gave me to understand that I was not to "monkey with any of the apparatus", and by no means take any of the instruments apart. I gave him the customary "Aye, Aye, Sir," and then proceeded as soon as he had departed to dis-assemble and disintegrate every piece of apparatus in the shack. I despaired of ever getting 'em all together again, for I apparently had enough parts for a couple extra sets. However it was finally done, but not until I had gained some interesting information.

In the first place their spark receiver was a crime. Honest, fellows, no good amateur would have such a set in his station. The material and workmanship was unexcelled. The hook-up looks like a Chinese puzzle. I have sent the circuit diagram to the Editor for a look, so I can



prove it by him that it would require a couple of college educations to decipher it. (Okeh—Ed.) Their trouble seems to be that they attempt to tune too finely. They have a thousand and one taps, intermediate and stand-by circuits, variable condensers with only two plates, etc., the result being that the inside of the set looks like the back of a telephone exchange. At any rate with the crystal detectors provided I couldn't make the darn thing bring in signals near as loud as they should.

Besides the spark receiver they had an audion outfit that was a combined undamped receiver and transmitter; a two stage amplifier; and a two K.W. quenched gap transmitter that was a bird. Believe me, their transmitters were as good as their receivers were bad. The accompanying photo of this transmitter shows its general construction. The quenched gap can be seen in the center while below it is the hot wire ammeter. The tuning is all done by variometers, the adjustment controls of which can be seen at the right and left sides of the set. The scales are calibrated directly in wavelengths and down at the bottom of the set are switches, each point of which corresponds to a different scale. The transformer, gap motor blower, and condensers are inside the set. The latter are built along the lines of the Murdock molded condenser. A frequency meter is shown at the top of the picture, while above it outside the view is a peculiar switch arrangement for starting the motorgenerator.

The motor generators—there were two of them—were not in the radio room at all. I looked for this part of the transmitting set for quite a while before I finally found it. I threw several switches and a hand starter that were obviously for the motor generator, and then opened the door of the radio shack and listened. Yes, there it was—stuck way back in the corner of the next compartment. I don't savvy yet their reason for having it in such a place. A switch outside the radio room marked "Umformer 1" and "Umformer 2" attracted my attention, and upon inquiring from someone who knew a little German I found that this ment motor-generator 1 and motor-generator 2. From that I inferred that there must be two motor generators. It then followed that I should throw this switch and utilize the afore mentioned listening procedure, which I did. I traveled nearly thru the boat before I found the second machine located 'way back in the electric control compartment. Of course the reason for having the two so widely separated was to insure radio communication even though one compartment became flooded.

The transmitters were designed for 425 meters, the U-boats working wave, and on that tune the HWA shot up to the maximum

scale reading, 16 amps when we were using the obstruction cables for an aerial. And speaking of aeriels, quite a bit was written during the war about the U-boat's radio. They were supposed to have aeriels raised aloft by balloons, tall masts, etc., etc. Well, I can say right here that that was all bunk. The U-boats had two aeriels, both very simple and ordinary. These were the obstruction cable, and the regular aerial. The obstruction cable was a pair of heavy phosphor bronze cables running from the extreme bow up over the conning tower

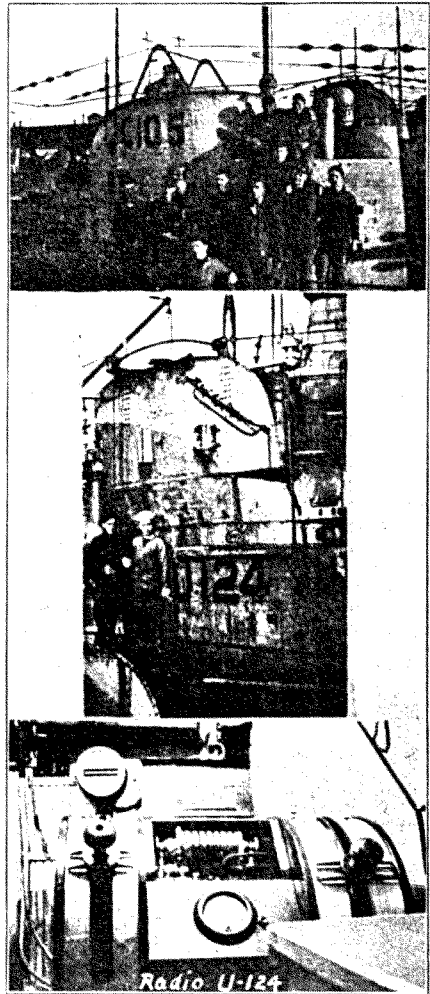

bridge to the extreme stern. These were provided so that any obstruction such as nets, etc., encountered under water would pass along the top of these cables up and over the boat and prevent its becoming

(Concluded on page 39)

## “STRAYS”

Don't seem at all good to be operating again, does it? Oh, no!

Fellows, it must be awful to be located so you can't run a set when you want to. We had a letter from poor old Kern, otherwise "Pinky", sometime 9GY, now a very busy student at Ann Arbor. Along comes re-opening and the little bug is biting him again. He says he's mightily tempted to chuck the whole game and go get a job driving a grocer wagon so he can have a chance to operate.

Deal, of 9NN in better days, is in the same boat, only at M. I. T. Who's going to take the place of these stations, down the Mississippi Valley?

Now to bust up that Thordarson contest!

Speaking of contests, we've one all our own. Read about it in this QST, and get right. Remember about the early bird, and be the first in your territory to get started.

Need any books? Don't forget the QST Book Department. A stack of literature here waiting for you fellows to write for it.

A tip to spark-coil operators: With a step-down transformer, of the type used for operating toys, lighting Christmas trees, etc., you can operate your coil very nicely on 110V. A.C., using the vibrator interrupter the same as with D. C., and eliminate the expense and nuisance of batteries.

Every once in a while we get a check for \$3.50 to cover A.R.R.L. dues and a subscription to QST. Of course we apply the extra \$1.50 for an additional subscription to QST, but everyone don't seem to know that the annual A.R.R.L. dues include QST for 12 months. Do your part to make this clear to the new ones in your vicinity.

We have a brilliant clerk. Every day he grows in radio knowledge. (Association, m'boy, association!) The other day we casually asked him if he understood what was meant by a "three-element vacuum tube." He said he had been reading about one such tube, "the only one the amateur can use", and that as he understood it the three elements in this case were Marconi, Moorhead, and deForest! Howzat?

Errata: Refer to pages 4 and 5 of August QST and make following corrections. In Fig. 7, add shunt variable

across secondary for tuning purposes. In the detector tube (center) in Fig. 4, the B battery is short-circuited by a dead wire. Insert by-passing condenser in this lead, the same as for preceding two tubes.

Wanted: Some more interesting war-stories of radio men, like the article by Mr. Crowdus in this issue.

Anybody working CW sets on 200 meters? We'd be glad to have a description of any that are proving successful. We're afraid we're going to have lots of trouble with 200-meter undamped. The frequency is so high that an extremely precise adjustment of the heterodyne frequency must be made at the receiver.

The only power tube available for us seems to be the so-called Marconi tube, made by Moorhead and licensed by deForest for the use of three electrodes. The Marconi Co. have enjoined deForest from the manufacture of the Oscillon, on the grounds that it violates the Fleming patents. It takes rather a stretch of the imagination to see how this can be.

The Marconi V.T. will make us a pretty good tube, tho. A set using one Moorhead type RH tube was hurriedly constructed at the Washington Navy Yard for use on the U. S. S. George Washington on the occasion of the President's first trip overseas, and with 750 volts on the plate this set was heard (telegraph) at Otter Cliffs when the George Washington was 1200 miles out. An interesting case, too, of "high-powered receiving vs. high-powered transmitting."

On Saturday mornings during the fall and winter months the Massachusetts Radio & Telegraph School is conducting a free course in radio for amateurs at their school in Boston.

The Post Office Department is going to erect short-wave stations at its various landing fields for use with the mail-planes. We understand the installations will be G.E. tube sets—C.W.

The demand for Wouff Hongs is decidedly on the up-grade. Also the desire to break into the shacks of certain little boys and carefully rewire the transmitters by leading every wire to the binding-post marked G.

Our British cousins are not yet operating. As a correspondent puts it, "We

have got a lot of washer-women in Parliament here who wear nothing but red tape." Perhaps the example of our own Navy Department will help.

You enterprising westerners: why not arrange a free service for tourists, reporting daily on the condition of the roads in various localities, detours, etc., and keep the information posted on a hotel bulletin-board? It would be gratefully received, and help to show some folks that amateur radio isn't a child's toy.

Another old-timer threatens to erect a record-breaking ham set. Mr. J. K. Hewitt, formerly of Albany where he acquired nation-wide fame as the operator of old 2AGJ, is now located in Philadelphia, and jointly with our Atlantic Division Manager, Mr. Chas. A. Service, Jr., aspires to build the best long-distance station that Philadelphia ever saw.

Tell us about your new apparatus, experiments with circuits, kinks, etc., so we can publish them and let everybody get the benefit. It is that co-operative spirit that makes our QST the best amateur mag. in the world. Its all ours—just think! And all of us help to make it what it is. The dope in it is real, because we are not printing articles written by chaps who just naturally have to write something on radio—anything so it's something—to get the price of a new winter hat.

A great many amateur condensers made from photographic plates employ two sheets of glass in each dielectric, to withstand the voltage. Mr. Elra E. House, of Battle Creek, Mich., introduces an innovation in such construction by shellacing narrow vertical strips of cardboard between the two glasses in such a manner that the oil, in which the condenser is immersed, may circulate by thermo action thru the very heart of each dielectric, keeping it thoroly cool. He uses four half-inch strips of cardboard between each set of glass plates. The strips on all the plates should line up when assembling, so as to take care of the stresses.

The oil in which transformers and condensers are immersed should be thoroly "dry." A very small percent of moisture greatly decreases the insulating qualities. The moisture may be removed by filtering the oil thru several layers of heavy blotting paper. A slow job, but it's worth it.

Every radio club ought to have a good wave-meter; in fact, the acquisition of a precision wave-meter has been the reason for the start of many a radio club. It is

worth its weight in VT's in tuning the stations of the members.

#### QST Chicago Amateurs.

A new radio organization has recently been formed in Chicago under the name of the Ravenswood Radio Association. It is believed to be the first of its kind, as all its members are the possessors of commercial licenses. It is, however, purely an amateur club and the restriction of having all members commercial licensed men was made merely with the intention of raising the standard of the amateurs. All those connected with the club are members of the A.R.R.L., the club's affiliation with the A.R.R.L. has been applied for, and practically all members are possessors of modern stations ready for relay work. It is a good live bunch of experienced amateurs. Membership is still open to applicants who can qualify, and every amateur is cordially invited to visit the meetings, which are held weekly every Tuesday evening at the club headquarters, 1917 Warner Avenue. Mr. N. E. Wunderlich is the Secretary, and he will be pleased to hear from those interested in this organization.

One of the most progressive amateur organizations of the country is the Radio Engineering Society of Pittsburg, of which Mr. Burton P. Williams is President, and Mr. C. E. Urban the Secretary. The club has grown rapidly, and recently opened its permanent quarters at 408 Second Avenue, Pittsburg, with a house-warming to which all local amateurs were invited. The club has an excellent station, an almost ideal receiving aerial, and a library is now being installed in its large and commodious quarters—all of which make a live radio club a thing of joy to its members. The Secretary edits a most interesting department in the Pittsburg Gazette-Times every Sunday under the heading "The Radio Amateur", and has done very commendable work therein in assisting in the removal of the amateur restrictions in co-operation with the A.R.R.L.

You juniors going up against your first Radio Inspector: take a tip. In the name of the Great Rettysnitch don't make the fatal error of showing your transmitter hook-up with a spark gap in the antenna circuit, or out the window you will go. It's poslutely against the law. Read up—see "The Junior Operator" in this QST.

Wot ho? Is it really possible that nobody except the ol' A.R.R.L. claims credit for getting off the amateur lid?

## THE JUNIOR OPERATOR

A great many requests come to us to run a page for the benefit of the less advanced experimenter to whom many features which the older relay birds regard as known by everyone may not be known at all. So with the hope of being of assistance to the younger fraternity we will endeavor each month to present items of help in this page. If there is some feature of general interest which you would like to have explained herein, the Editor will appreciate a line from you.

### AERIALS.

"How long can my antenna be for 200 meters?" is a frequent question. It depends on the aerial—and its location. For work on amateur tunes, and for both sending and receiving, a four-wire flat-top "inverted L" aerial is as good as any. It is almost impossible to forecast the natural period of an aerial, as its capacity depends so much on the nature of the structure between it and the ground and on the presence of nearby metal objects, trees, etc. Absolutely the only satisfactory way is to erect it and then measure its period with a wavemeter. For operation on 200 meters its natural period should be around 170 or 180 meters, the difference to be made up in the inductance of the oscillation transformer or helix in the station. In general we can say that a four-wire inverted L flat-top, wires spaced 3 feet apart, will have about the right values when the total length of flat-top, vertical portion, lead-in, and ground lead (to point of actual contact with the soil) is 110 to 115 feet.

### HOOKING UP TRANSMITTERS

The sending set must be arranged to have two tuned circuits, with the spark gap in the primary or closed circuit. Once upon a time the circuit shown in Fig. 1 was used a great deal by beginners in the

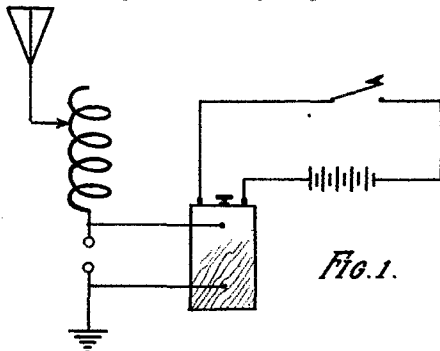

FIG. 1.

art, under the mistaken supposition that it provided the utmost range for their set. Since 1912 it has been prohibited through-

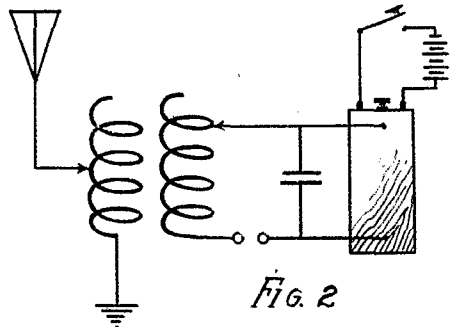

FIG. 2

out the globe by International Convention because it causes great interference and a small spark-coil set using this hookup can completely put a kibosh on everything within its range. It radiated a "broad wave", which is to say that it has no particular tune at a receiving station but instead may be heard as well at one adjustment as at another, so that there is no method of tuning it out to receive other signals. This effect is caused mainly by having the resistance of the spark-gap in the antenna circuit, and to remedy it the gap, with a condenser, is put in a separate circuit and coupled to the antenna circuit magnetically, as shown in Fig. 2. This shows an oscillation transformer, but that is not imperative, as the same result can be secured with a straight helix if it is provided with three clips as arranged in Fig. 3. Note that in this diagram the turns comprising the closed circuit are entirely distinct from those in the aerial circuit; in other words, no turns are common to both circuits, and it is by regulating the number of turns in common that coupling is controlled in such a circuit. Three clips are essential, for otherwise the coupling would be so close that a broad wave would still be sent out and the set would not comply with the law.

Right here we'd like to call attention to certain knock-down spark-coil sets which are being shown in department stores for the holiday season. These sets use the helix only as a loader, as in Fig. 1, and show the gap in the antenna circuit. You absolutely can not get a license for such a set, and it is illegal to operate it unless the circuit is changed as in Fig. 2 or Fig. 3 so as to get the spark-gap out of the radiating circuit.

A fixed gap is the only one that can be used with a spark-coil. Many amateurs know that a rotary is unsatisfactory with a coil but not all know why. We will try to explain it as follows: In a transformer set operating on alternating current, the high-tension current flows evenly back and forth in each direction just the same as the input current did, so that the condenser is charged during every alternation, and so a rotary gap works all right. In a coil, however, the current does not alternate. Instead it is merely interrupted by a vibrator, and vibrators are constructed in almost all cases to give a high-speed "break" and a slower "make". The result is that a coil has a very high-tension secondary current at "break" but practically none at "make". In other words, a spark-coil is idle about half the time, and if a rotary gap were used under these conditions its lugs would come together at times when there was no charge in the condenser.

The best gap for a coil set is a stationary gap with a fine screw adjustment,

equipped with cooling flanges to prevent the electrodes from heating, and mounted on a base of good insulating material

#### LEARNING THE CODE

The best way to do this is to have a partner. It requires lots of hard work and time, and only by conscientious application can one become a good operator. The Editor believes the easiest way to be to first memorize the code thoroughly, so that that you can say to yourself "Q is two dashes, dot, and a dash", and so that you will immediately remember that three dots is S, etc. This is the easiest part, however, as even after this is done you won't be able to tell a dot from a dash when you hear it. A practice buzzer set is the next thing. Practice the alphabet until every letter is familiar, alternating with your partner. Then try spelling out simple words the same way. Don't try to progress too fast, and it is important to never attempt to send faster than you can receive. When you can recognize words you are ready to attempt simple conversation back and forth, and it is surprising how quickly a speed of six or eight words a minute will be attained. Then you have all the rudiments, and it is simply a case of sticking with it diligently, and you will find that every week your receiving speed goes up a few notches. In practicing, avoid writing down the characters forming a letter. Learn to think quickly and train yourself to identify that combination of characters instantly. If you miss a letter, in most cases the sense of the matter will show you what it was.

Your sending speed will take care of itself, as if you can read you can send. But of all things don't attempt to send "fancy". There's not a thing to it. Dots are dots, and dashes are dashes; make them so if you expect the other fellow to "get you".

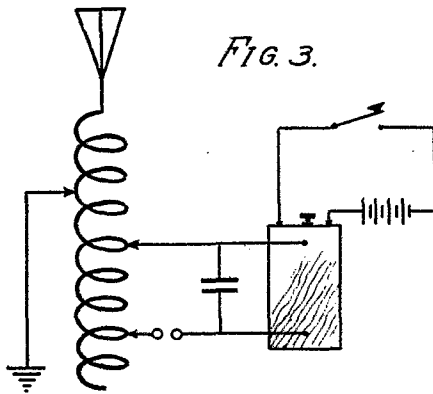

#### Notes on the Quenched Gap

(Concluded from page 28)

words, that the quenched gap is over three and one-half times as effective as the rotary.

With the rotary gap considerable difficulty was experienced with kick-backs which punctured the insulation on the transformer and blew fuses, etc. With the quenched gap, however, none of this trouble was noticeable. In operation the quenched gap was almost noiseless, which is an obvious advantage when it is considered that a great deal of amateur long distance transmission is accomplished in the early hours of the morning, much to the discomfiture of the household and neighbors. With a rotary gap very high potentials are built up in the antenna circuit, which tend to strain and even rupture

the insulation. With a quenched gap this is not true, as the sparks follow each other regularly and are of uniform potential.

Briefly, then, we may sum up the advantages of the quenched gap over its nearest competitor, the rotary gap, as follows:

1. Increased efficiency of transmitter.
2. Practically noiseless in operation.
3. Less potential in antenna system.
4. Decrease in decrement of emitted wave.
5. A clear note without the use of moving parts.
6. Less trouble due to kick-backs, etc.

With such an outfit the standard of the amateur will be nearly on a par with the commercial companies operating today, and it is to be expected that with a transmitter of this type and an efficient receiver, far greater distances will be spanned by the amateur than in pre-war times.

# Radio Communications by the Amateurs

The Publishers of QST assume no responsibility for the statements made herein by correspondents.

## QST BROOKLYN AMATEURS

—An Invitation—

Editor, QST,  
Hartford, Conn.

The prevalence of inefficient operating was responsible for the organization of the Radio Traffic Association of Brooklyn, N. Y., in January 1917. It is again preparing to carry out its main objects which are to minimize unnecessary interference and reduce inefficient operating by the dissemination of practical ideas. It also purposes to promote good fellowship and establish an efficient relay system among the amateurs of Brooklyn.

At present the officers are, Ferd. C. W. Thiede, Chairman, Albert R. Heydon, Secretary; Ernest K. Seyd, Financial Secretary; and Clifford J. Goette, Treasurer.

All amateurs of Brooklyn, above the age of eighteen, desirous of connecting with an organization offering obvious advantages, are cordially invited to communicate with the Chairman at 486 Decatur Street, Brooklyn, N. Y.

Very truly yours,  
Radio Traffic Association.  
A. R. Heydon, Secretary.

### ANYBODY HELP HIM?

Dear Editor:

It seems as though the monthly visits of "QST" out in this part of the country are the only things to keep a fellow interested in amateur radio. For a week or so after getting my copy things look fine and prospects for a good "season" are fine but after the first week or so and after listening to the general line of stuff that is in the air I lose faith and begin to believe that we never will again hear the old familiar 9s and 8s and GVs and RDSs, etc. I have often wished that QST was issued weekly but that is a little bit too much to ask.

A peculiar condition exists in this town of near ten thousand people. I am the only one in the whole city that is more than ordinarily interested in wireless. To get assistance in erecting masts is like pulling hens teeth. It can't be done. If I want to put up anything higher than 40 feet (and I have passed the stage of being satisfied with 40 feet) it is necessary to hire somebody to assist me at a rate per hour that would make the average ship builder green with envy. BUT every cloud has a silver lining. When we get back on the brass, local interference will be nil. No inter-

ference in a town of this size is another condition that I'll bet obtains in no other place in the country. But for my part I'd rather have the interference and help and brotherly interest in the game than this trying to keep up one's enthusiasm by listening to NAA, NAR, NAJ, NAT, NAW, etc., etc., almost without end. What I want is to hear "HOW IS MY SPARK", "HOW IS MY TONE". That stuff don't amount to anything of course but at the same time it is the stuff that amateur wireless is built on, for we all started that way. This wail that I am unloading on you won't help things in the least but I have got to tell it to some one and maybe some of the other readers can get some sympathy out of it.

Another thing that I have on my chest is this. When orders came out that we could listen in I hooked up what I had on hand consisting of an Audiotron and a medium sized loose coupler with a slider on the primary and a couple variables etc. For the first week I heard nothing. Absolutely nothing. I tried every conceivable way to induce some of those nice musical wireless signals to come down and rest a minute in my phones, but nothing doing. Finally after considerable cussing and spitting on the cat (apologies to the "Old Man") I remembered that I once read that a magnet held at certain angles to the bulb would increase intensity of signals. I tried it. Since then I have heard stations that before the war were far beyond my reach. Such stations as KKO (Southern Pacific Steamship "Excelsior") roll in as pretty as you please. It takes extremely close adjustment of the magnet but it sure gives results. There probably is something the matter with my circuit although I am using the standard Audio-Tron hook-up. If anyone can throw any light on this subject it certainly will be greatly appreciated for it is very unhandy to be pushing and lifting a large magnet around on the operating table.

Well, I thank you for reading this line that I sling and hope with you and five thousand others that before long we can be listening to the heart-interest stuff that was in the air before the war.

Sincerely,

G. R. Hammond, Asst. Dist. Supt., A.R.R.L.  
219 Fifth Ave. South,  
Oelwein, Ia.

**MORE ABOUT V. T's.**

New York, September 17, 1919.

Editor, QST,  
Hartford, Conn.

Dear Sir:—

I have read Mr. Hassel's article on the VT's in the September number with a great deal of interest, and concur with him in general throughout. I would like however, to bring to your attention the fact that this company is at present putting on the market for amateur use through the Marconi Company, as their distributing agents, a type of tube having the standard VT characteristics, but with a detector sensitiveness equal to or better than that of the old type de Forest gaseous tubes.

This tube is the result of development work done jointly by this company, the Marconi Company and the Moorhead Company, and it is designed especially for amateur use, to fulfill the rigid specifications that they insist upon. While being a sensitive detector, and as good an oscillator as the old tubular type de Forest gaseous tube, it has the distinct advantage of the standard four prong base, and a filament life two to three times greater. These tubes may be obtained directly from the Marconi Company. They have the disadvantage that the B battery adjustment is critical, and they therefore require a variable B battery, as was the case with the old style audions. They are not designed to be used as amplifiers, as the standard de Forest VT audion or the Marconi VT is highly exhausted for this purpose.

I also wish to notify the amateurs through your columns that the infringing manufacturers of the old type de Forest gaseous audions will soon be enjoined, so that this type of tube will be no longer available.

Very truly yours,

(Signed) Robt. F. Gowen.  
For De Forest Radio Tel. & Tel. Co.**OUR CHEST IS OUT.**

Mr. Gilbert E. Maul, of Chatham, N. J., writes us an encouraging letter, in part as follows:

"Dear Eddy:

Say boy, if U keep on putting QST out like U did the Sept. nr., everybody in the good old USA will go rdo crazy. Gee, when my copy came it was so thick I thot U were doubling the advertising section, but when I saw that it was chuck full of all good things like loops, VT transmission, CW receivers, amateur situation, etc., I said to myself 'that K. B. W. certainly is busy this month all right!' Not to mention Here & There. Good stuff. Don't worry about short articles once in a while. Short and snappy—that's us! Spark coil panel

set—good dope. More CW stuff and loop aerial articles, too

Well, regards to A.R.R.L. and QST. Excuse bum writing but am on a train and QRM is fierce at 50 m.p.h."

**OUR LIFE'S NOT ALL ROSES.**

222 Cherry St.,

Dunmore, Pa., Sept. 24, 1919.

Dear Editor:

I have been trying the Crowdus hookup out as described on page 7 of the Sept. QST and I don't think much of this alleged "hook-up". In the first place it is a fussy old hookup that is nothing more than the deForest hookup or ultraudion of 1907, plus the Armstrong feed-back coil, and we all gave that up before the war. I wish you would tell me why they need the two circuits or wires to the plate. I had a letter from our mutual friend S. Kruse in Washington, and he gave me a hookup that is the best that I ever used. Several of the boys use it here and will swear by it as the easiest hookup to handle. Will you tell me why it is not advocated in QST? Why in the devil do you try to make the boys think they are getting something new, when it is the same old cigar with another label on it? And last of all, I notice that you use a condenser on the tickler on page 4, August QST. We cannot make any use of this condenser on any tickler. And we find, as you say, the deForest anti-static circuit spoils the whole set.

H. E. Blackburn.

(We took this awfully to heart, and we've tried to clear up some of these points in this issue. Mr. Blackburn's hook-up—the one he likes—is the old reliable tickler with straight audion—Ed.)

**"NOTHER "TRADE-LAST"**902 Second St.,  
Beaver, Penna.

Dear Editor:

I don't know exactly when my sub. expires but I'm not going to be caught napping and lose a number of our lil ol' QST. Therefore enclosed is a money order for \$1.50 for which you will please continue my subscription.

And "dear Eddy" (apologies to 9HS), may I tell you what I think of QST? It's the BEST (not one of the best)—the best radio magazine going, and I've seen 'em all. I'm beginning to think there is someone up there whose brains are "geared" exactly the same as mine. Honest, I sit here reading one of your articles and try to dope it out and pretty soon some question forms itself in my mind. I read on and sooner or later every one of those questions are answered just as I wished them to be. Strange but true.

Several times, some of the blooming young hams down this way come to me and ask me what I think about—well, the new V.T's. I tell them that I don't know much about them except what QST says about them and go on to tell them. I always end my "sermon" by telling them that if QST said the moon was made of green cheese, I would believe it. As soon as possible I'll touch 'em up for a subscription, huh? (Yea, Bo. —Ed.)

Well, you've had enough of this, so best wishes to QST and the A.R.R.L.

Yours, etc.,

Geo. R. Boardman, Jr. (Ex-8AH)

### CLEANING BRASS PARTS.

Mr. Charles Stanley Gridley, of Chicago, had an idea one day and it worked, and so he writes the Editor:

"I wanted to remove the tarnish, oil, dirt, etc. from some brass parts, such as clips, contact points, switch levers, etc., and decided to try this stunt. Make a strong solution of hot water and "Gold Dust" and put on the stove and boil. Empty the things to be cleansed into the solution and boil for a few minutes. Remove and thoroughly wash in water, then dry and polish with a soft cloth. The scheme works great, and now that amateurs are renovating old material, especially brass, it may be a good practical suggestion"

### MORE ROSES.

Pneumatic Stamp Co.  
Binghamton, N. Y.

Dear Sirs:

I received my QST O K. and I want to say this, I get so Goll Darned Oscillated over that paper, that I never think of eating my supper

I start to read it, and I want to make all the things in it. I feel like buying all the instruments advertised. I get a new ambition, therefore I rip off my connections on my set and hook it up a different way. Oh, I have an awful time when I receive QST. That's the best radio Mag. in the world.

Chas. Reynolds.

### SCOOP!

The Radio Club of Mansfield.

Mansfield Ohio, October 3rd, 1919.  
The A.R.R.L. Inc.,  
Hartford, Conn.,  
Gentlemen:—

The good news received today along with QST. I certainly was surprised myself, but the other hams who hadn't received their issue of QST yet couldn't believe it at all, so I trotted around town with your pink notice "BAN OFF" as if it were the Declaration of Independence or something.

Several months ago I got the gang together and we all decided that we were off of this back yard radio stuff for good, so we all chipped in enough for a couple thousand dollars, bought a site, poles, four step amplifier, 1 k.w. quenched and 5000 square feet sheet metal for a ground system.

Station wont be completed for a couple of months yet, but when she is you can count on us to see that the trunk lines swerve thru Mansfield. As soon as we can we also intend to install a Radio Telephone and C. W. apparatus.

Am getting all the new birds lined up for subscriptions both to QST and A R.R.L. Hoping that we may soon hear you pounding the brass again down in Hartford and that the Old Man's Woof Hong is still well preserved on your shelf for antiquities, I am

Sincerely yours,  
C. C. Endly, President.

### WANNA JOB?

Dear Editor:—

Enclosed please find \$1.50 for year's subscription to QST, and also announce that I will be "shootin' the breeze" sometime in the near future; that is, if there are a couple fellows want my job and 3AEP's with it. Have done some amateur work in Philadelphia up to 1915 when I entered the commercial game, but on account of being married will have to knock off and show these amateurs in North Carolina what amateur work is.

You no doubt remember 3AEP, J. F. Rau, from Philadelphia. Anyway, he will be out at the same time I go, and between us two we will be there strong and hope that QRM has been QRT by then.

By the way, send me your Wouff Hong for about three minutes so I can start clean up week when I open up, as the younger generation has already bought the automobile man out of Ford spark-coils and with the direction finder we will be able to use the W. H. to fine advantage.

Well O. M. I will QRT for this time, and look for the next issue of QST.

Yours for the better days,  
C. A. Roethlinger,

U.S.S. Seminole, Wilmington, N.C.

P.S. If you happen to know any men who want a job on this cutter, let me know. 1 Chief Elect. and two 2nd-cl. Elect—ship for one year.

### MAKING WIRELESS APPARATUS.

To the Editor of QST:

One night when I was waiting for the sun to get low enough for me to ascend to the attic, where I have my little set, without being half baked, I picked up a Radio magazine. From start to finish it



was nothing but how to make apparatus. I thought then of when I was a little ham just starting how I looked with great awe upon such articles and after I had read them over I would go to bed and dream of Micro Henries and the rest of the Mikes and get up groggy the next morning.

Making your own apparatus is great and I take my hat off to the fellow who makes his set and has it working O.K. any time day or night, but how about the little fellow who hardly knows what size wire to use, buys a lot of stuff he can never use and then, after he works for over a week finds out that what he has made wont work? Take my advice, fellow amateurs who are just beginning; buy your first set from some reliable company and then, after you have had some experience handling radio apparatus make a set of your own design.

Another thing that I have noticed among beginners is that they do not know how to buy. They usually send to some concern who offers great bargains (on paper) and then when they receive the goods find that it is of no value. Also, amateurs, buy an audion set. Why bother around with mineral when for a little more money you can purchase a real set? Most of the bugs eventually buy one and then find that they have a galena detector and some bum fixed condensers that they can't use. Why waste time and money? Make your set right in the first place and afterwards think of experimenting with mineral and making apparatus.

"Bugs".

### 3RO HEARD FROM.

W. T. Gravely, sometime 3RO, writes us as follows from Danville, Va:

"All quiet down this way, insofar as radio is concerned, and I am looking for practically the same conditions to exist in future as existed before we entered the war, that is, a small number of stations. My outfit will likely be the only one in the city, not counting the little fellow with his spark-coil, for he is ever present.

Since April 15th I have erected a single strand, which runs in no particular direction, and have heard most of the arcs in this country: NSS, NFF, NWW, NDD, NAW, NAT, NAU, NAA, NAO, NPL, NBA, and others. Have also heard several of the foreign stations but have never been able to catch them signing and while I think I know who they are, they are not claimed until I am certain and have heard them sign a time or two.

The fact is I have had so very little time to listen that I cannot hope to check up all I hear. Yet it is splendid to be able to open shop once more and don a pair of phones when one has the time and the inclination. My transmitting apparatus is still boxed but can be gotten out and tuned up in an hour or two after the word has come to go ahead. I'd like to have the old call 3RO again, but don't think Baltimore anticipates bothering about such matters."

### U-BOAT RADIO

(Concluded from page 31)

entangled or injured. By simply placing insulators at the ends of these cables and attaching a lead-in, they made a very good aerial. The regular aerial, however did show an improvement over those found on the subs of the allies. The Germans had two steel masts, one fore and one aft, that folded over by a system of gears at their base into a recess in the deck. They were raised from inside the boat by electricity or compressed air. Two phosphor-bronze wires stretched tightly between them made up the antenna. These masts were about 35 ft in height. The aerial wires were always stretched tightly between the masts whether they were erected or lowered, for the masts were moved absolutely together and the tightness of the wires thereby maintained. On "our" boat one of these masts was cracked at the base so we were unable to raise it and had to use the obstruction cable aerial entirely.

The combined audion receiver and transmitter mentioned above was more or less of a mystery. No one was able to get one of them working at the time and I am somewhat inclined to believe that they had been "fixed" so they wouldn't work. They were certainly acmes of construction. In fact, all the German apparatus was made to stay made. The two stage amplifier I got working after some trouble. The results were disappointing, however, for it didn't amplify like a real two-stage should. The German vacuum tubes were inferior to ours; in fact they were declared by some who claimed to be experts to be five years behind our own. One peculiarity about the German sets was the absence of binding posts. Not one was in sight, the plug-in system being used entirely. The transmitting key—well, it was certainly a crime. It weighed about 4 lbs. and the lever about 3 lbs. It was characteristically German, for it would take a big overgrown Dutchman to manipulate it. Anyone wishing to take a look at said key call around at my shack—for there it will be found on exhibition.

# Transmitter Efficiency

By M. B. West

**I**N wireless, as in other arts, sometimes things are taken for granted which would on second thought bear investigation. The modern 500 cycle commercial transmitter has been developed, I believe, solely on the statement that the telephone receiver responds with considerably louder signals to a high frequency than a lower one. Every amateur knows that with a limited power input a very much lower spark frequency than 1000 per second gives the greatest range. It is easily understood that with a given power input there will be just three and one third times as much energy in each impulse in a set that gives 300 sparks per second as in one that gives 1000 sparks per second, altho if each were equally efficient the hot wire ammeter reading would be the same, since the hot wire ammeter reading represents the average current value. I do not believe that any one would be so rash as to make the statement that a telephone receiver is  $3\frac{1}{3}$  times as sensitive to WEAK signals at 500 cycles as it is at 150 cycles. It is unfortunate for the amateur that the quenched gap was introduced commercially before the rotary gap was developed to its highest efficiency.

In working with high frequency currents it is soon noted that the difficulties and losses encountered are very much greater as the wave length decreases. On the other hand energy is radiated very much better at the lower wave lengths. By careful attention to design and construction many of the difficulties can be overcome and losses partially prevented at least, in a manner that should for the purposes of the amateur produce results that are not ordinarily attained in commercial work. The design of the gap used is by far the most important factor tho by no means the only one. The ideal gap is one that possesses infinite resistance till the moment of discharge, zero resistance during discharge and infinite resistance after the useful energy is transferred to the open circuit. In explanation, suppose a condenser is charged to 20,000 volts potential and suddenly connected to a circuit having no inductance and a resistance of 1 ohm. It is evident that a current of 20,000 amperes will flow in that circuit for a length of time, depending on the size of the condenser, and almost instantly this current will decrease to zero. Just think what a "kick" such a current would give your antenna. Of course a primary circuit permitting such a condition is impossible, but let us enumerate the things that make it impossible. First the factor of resistance.

We can reduce this to a very low factor by making the condenser itself of material possessing good conductivity. The loss in the dielectric is in effect resistance and we can substitute oil for the usual glass and thereby decrease this loss 80 per cent. And of course as has been often repeated, we can construct the whole primary circuit so as to have low resistance. We hardly expect to reach 20,000 amperes in our closed circuit, but just go to some power plant and look at the size of the bus bars provided to carry a current of 1,500 amperes and then go home and look at your closed circuit and draw your own conclusions. Then the resistance of the gap itself. This depends on the clearance between the moving and stationary electrodes and on the number of square inches of surface provided for the current to jump from and toward. Ask your electric light man how big a carbon he would use in an arc lamp using 1,500 amperes and then go home and take another look at your gap.

Next comes the factor of inductance. Fortunately we don't need much of that, but let us make what we must have effective for the purpose for which it is needed and that is to transfer the energy to the open circuit. Consequently we can go so far as to make the leads from the condenser plates through the gap and back absolutely straight except for the turn in the oscillation transformer itself and of course the necessary "fan" as the leads to the individual condenser plates separate. It would be ideal to mount the rotary gap on a vertical shaft directly above the condenser and have the primary of the oscillation transformer consist of one vertical loop directly above that. Also, if one must have, for any reason, leads from the condenser of any appreciable length, run them close together, so that their inductance is neutralized as far as possible.

Now comes the problem of closing the circuit suddenly thru a gap that will have low resistance at the moment of closing. The difficulty is that as the electrodes approach each other the spark WILL JUMP TO MEET the approaching electrode thereby closing the circuit at a time when the gap has a high resistance. Brush discharge from the approaching electrodes is the chief difficulty encountered here. If you do not believe this, close your key with gap stationary and the electrodes just separated far enough so that the spark does not jump and examine the whole closed circuit in the dark.

This difficulty can at least be partially overcome in two ways. First, by so constructing the electrodes that either rounded or flat surfaces are presented as the electrodes approach each other and secondly, by increasing the number of gaps. The writer, in company with Mr. Clausing, formerly of 8YL, constructed and tested practically every form of gap ever described in print and we believe a number that have never been described. One type in particular illustrated the point of brush discharge very well indeed. This particular gap was similar to the much discussed saw tooth gap in that both the stationary and moving electrodes were of copper strip and set at a considerable angle to the radius of the disk. When this gap was revolved "forwards" so that the ends of the electrodes approached each other the spark would jump fully  $\frac{1}{2}$  inch to meet the approaching electrode but when it was revolved the opposite direction this was reduced to less than  $\frac{1}{8}$  inch. No other changes were made in the circuit. The number of gaps that may be effectively employed seems to be limited by the amount of inductance in the primary circuit and the clearance between the electrodes. The writer constructed a gap having twelve pairs of electrodes in two straight lines and found that for a wave of 208 meters 4 gaps in series with a clearance of .015 gave decidedly the greatest radiation while at 400 meters six gaps were decidedly preferable. As it was only possible to vary the number of gaps by twos, (as 2, 4, 6, 8, or 10 in the circuit) it is entirely probable that 3 or 5 gaps might have produced much better results as the difference between 2 gaps and 6 gaps was appreciable and the difference between either 2 gaps or 6 gaps and 4 gaps was very great indeed. However, the matter of the number of gaps is not nearly as important as the shape of the surfaces presented, altho the added efficiency gained by the use of four gaps is well worth the troubles involved in construction.

Next in order is the problem of stopping the discharge as soon as the effective energy is transferred to the open circuit. This problem of "quenching" is not so difficult as is commonly supposed, and this statement is borne out by the fact that almost any amateur set with a good ground and an antenna of fairly low resistance, if properly tuned to resonance, is well within the legal requirement as to decrement. Two methods of accomplishing this result are possible. First by making the sparking surfaces as large as possible. This, of necessity, consists in making the edges of the electrodes wide as they approach each other, as the possible speed of rotation does not permit the utilization of surfaces extending more than perhaps  $\frac{1}{8}$  inch in

the direction of the circumference. Wide electrodes have also the desirable factor of decreasing the resistance, which is extremely desirable. The writer was engaged in experiments just previous to April 6, 1917, to determine the effect of the width of the electrodes, but for obvious reasons was unable to conclude them. However, gaps were constructed with electrodes varying in width from that of points to a width of  $1\frac{1}{2}$  inches and it was noted that as the width increased the length of the portion (measured circumferentially) which was discolored by the spark decreased. The width of the electrodes employed should be as great as the spark will fill and from such experiments as I have been able to make this width would seem to be at least  $2\frac{1}{2}$  inches. The second method is by increasing the speed of rotation in order to more quickly reduce the separation of the electrodes. This is not particularly effective unless the clearance of the electrodes is kept very small indeed. The writer succeeded in constructing a gap having an eight inch disk revolving 6,000 RPM with four stationary electrodes having a clearance of .015 inches that was satisfactory and ran for several months without any trouble whatever. It was noted in increasing the speed from 3,000 RPM to 6,000 RPM and reducing the number of moving electrodes from six to three, that while the spark jumped as far to meet the approaching electrode as at the slower speed and continued as far over the surface of the electrodes as before, yet this result was accomplished in just one half the time with a corresponding decrease in the number of oscillations. A further increase in speed should be possible and a still larger disk could no doubt be successfully used.

My conclusions are that the ideal gap for a 200 meter transmitter must have wide electrodes, have the approaching corners smoothly rounded or beveled, have at least  $\frac{1}{8}$  inch of flat surface with extremely small clearance, revolve at very high speed, consist of four gaps in series and have the current path thru it consist of one or two straight lines and not with as many as eight right angles as are seen in some gaps used. Every successful gap that I have seen or seen described has been developed along one or more of the principles outlined.

It is very easy to measure accurately the efficiency of the gap you are using. Get a piece of smoked glass and examine the spark while the gap is running. You can estimate quite accurately just how far the spark jumps to meet the electrode and just how far the disk moves before the spark is extinguished. Divide the RPM by 60 to secure the number of revolutions per second. Multiply the circumference

of the disk in inches (at point where electrodes are mounted) by the number of revolutions per second, this giving the number of inches per second that the electrode travels. Using the fraction of an inch that the electrode travels in the duration of the spark as a numerator, the distance per second that the electrode travels as a denominator and multiplying by 1,500,000, the number of cycles per second for 200 meters, you secure a very close estimate as to the number of oscillations occurring during the passing of the spark. It should be easily possible to reduce this number to at least 35 and while that is considerably more than the necessary 4 yet it is a very great deal less than 300 or 400 which is about the usual result with the ordinary rotary gap.

The overall efficiency and range of any transmitter will be found to vary almost directly with the number of oscillations per spark, the range and efficiency increasing as the number of oscillations decrease. Poor resonance between the closed and open circuits, a poor or small antenna, a poor or long ground or any other bad condition in either circuit will be reflected in the behavior of the gap. A number of amateur stations have made remarkable records which violated every principle herein advocated but in every instance they will be found to have had the advantage of extraordinarily high antennae or have used excessive power or wave length and we can rest assured that we will be held more closely to the requirements of the law in the future.

M. B. West.

## QST's Directory of Calls

**E**ACH issue until the appearance of the Department of Commerce's List of Radio Stations containing amateur calls, QST will publish all reported call-letters. You are urged to co-operate with us and help to make this as complete as possible. QST can perform no more important duty in these days of reorganization than to keep us all posted on this subject. Do your bit by telling us your call as soon as it is assigned you.

### First District

Wallace E. Heckman	119 Windemere Road, Auburndale, Mass.	1AA
H. M. Lane	27 Linnehan St., Cambridge, Mass.	1AB
L. L. Perkins	460 Walnut St., Brookline, Mass.	1AC
Chas. S. Doe	13 Artwell St., Milton, Mass.	1AD
S. B. Young	294 Ashmont St., Dorchester, Mass.	1AE
Harvard Wireless Club	Harvard Union, Cambridge, Mass.	1AF
Walter R. Weeks	67 Pleasant St., Marlboro, Mass.	1AG
Alfred Hall	Main St., Norfolk, Mass.	1AH
Clayton A. Thompson	142 Glenwood St., Lynn, Mass.	1AI
H. Kurth	126 Columbia St., Cambridge, Mass.	1AJ
H. C. Bowen	168 Belmont St., Fall River, Mass.	1AK
G. R. Entwistle	137 Sutherland Road, Brookline, Mass.	1AL
Fullerton D. Webster	12 Hampshire St., Everett, Mass.	1AM
William C. Kohl	75 Richardson Road, Melrose Hglds., Mass.	1AO
R. W. Mathewson	872 River St., Hyde Park, Mass.	1AP
C. S. Gould	123 Hamilton Ave., Lynn, Mass.	1AQ
Benjamin B. Coleman	193 Clasp St., Milton, Mass.	1AS
Jacob Coolikoff	48 Cutler St., Winthrop, Mass.	1AT
C. D. Davis	8 Cedar St., Wakefield, Mass.	1AU
H. W. Randolph	419 Chatham St., Lynn, Mass.	1AV
Hiram Percy Maxim	276 Whitney St., Hartford, Conn.	1AW
J. A. Campbell	9 Fairlee St., Somerville, Mass.	1AX
C. D. Tuska	136 Oakland Terrace, Hartford, Conn.	1AY
Geo. U. Readio	62 Yale St., Springfield, Mass.	1AZ
Arthur Ferguson	52 Linden St., Everett, Mass.	1BA
Stewart Perry	38 Pleasant St., Winthrop, Mass.	1BB
Ralph A. Reed	8 Cedar St., Wakefield, Mass.	1BC
C. J. Westman	347 Cambridge St., Cambridge, Mass.	1BD
Henry W. Wickes	83 Woodside Ave., Winthrop, Mass.	1BE

Ernest Wood	2 Baldwin Terrace, _____	1BF
C. F. Shorey	249 Grove St., Melrose, Mass.	1BG
Wilbur H. Hardy	776 Hale St., Beverly Farms, Mass.	1BH
Geo. D. Darling	30 Swains Pond Road, Melrose, Mass.	1BI
E. S. Herrick	5 Gladstone St., Greenwood, Mass.	1BJ
D. F. Alexander	209 Elm St., Bangor, Maine	1BK
Homer E. Nichols	513 Pequonnock St., Bridgeport, Conn.	1BM
Russell Noyes	62 Austin St., Newtonville, Mass.	1BN
Clinton H. Turner	Haverhill St., No. Reading, Mass.	1BO
F. W. Osborn	21 Highland St., Framingham, Mass.	1BP
W. R. Mercer	34 Webster St., Allston, Mass.	1BQ
H. C. Ellison	77 Russell Ave., Watertown, Mass.	1BR
C. T. Caswell	106 Franklin St., Framingham, Mass.	1BT
C. R. Stevens	9 Maynard Road, Framingham, Mass.	1BU
L. G. Cummings	83 Marlboro St., Boston, Mass.	1BV
R. H. Shaw	101 No. Central Ave., Wollaston, Mass.	1BW
W. P. Southworth	122 Chestnut St., Wakefield, Mass.	1BX
L. B. Davis	12 Phillips St., Watertown, Mass.	1BY
W. W. Patten	38 Franklin St., Watertown, Mass.	1BZ
J. D. Conboy	12 Beethoven St., Roxbury, Mass.	1CA
L. H. Daykin	339 Beacon St., Somerville, Mass.	1CB
Alfred J. Sivigny	67 Dalby St., Newton, Mass.	1CC
A. P. Graham	19 Gardner St., Woburn, Mass.	1CD
Francis LeBaron	407 Ash St., Brockton, Mass.	1CE
F. C. Bowditch, jr.	164 Rawson Road, Brookline, Mass.	1CF
F. W. Woodworth	173 Bunker Hill St., Charlestown, Mass.	1CG
P. B. Holmes	21 Rockledge Road, Newton Hglds., Mass.	1CH
Henry Slayter	90 Chester Road, Belmont, Mass.	1CI
Arthur Kybert	318 California St., Newton, Mass.	1CJ
Philip F. Robinson	149 Halls Ave., Braintree, Mass.	1CK
E. C. McMahon	9 Vernal St., Everett, Mass.	1CL
Harry Finkelstein	93 Maverick St., Chelsea, Mass.	1CO
C. E. Howell	139 Summer St., Watertown, Mass.	1CP
B. F. Stewart	217 Crafts St., Newtonville, Mass.	1CQ
Charles R. Stevens	19 Agassiz St., Cambridge, Mass.	1CR
F. B. Swett	154 Central St., Saugus, Mass.	1CS
J. L. McGrath	206 Fayette St., Wollaston, Mass.	1CT
F. A. Hurd	159 Bradford St., Everett, Mass.	1CU
Ole M. Hovgard	71 St. Mary St., Brookline, Mass.	1CV
J. S. Day	47 Madison St., Revere, Mass.	1CW
Robt. S. McArthur	2 Cambridge Ter., Cambridge, Mass.	1CX
F. M. Oliver	309 Washington St., Braintree, Mass.	1CY
E. J. Gallagher	16 Appleton St., Atlantic, Mass.	1CZ

#### Second District

No licenses issued up to time to going to press, but following stations temporarily authorized to transmit using old call, pending receipt of new licenses:

J. O. Smith	Rockville Centre, L. I.	2ZL
Lester Spangenberg	Lake View, N. J.	2ZM

#### Third District

Temporary authorization pending receipt of new license:

Chas. A. Service, jr.	Bala, Penna.	3QZ
-----------------------	--------------	-----

#### Eighth District

No accurate data, but via radio we have heard:

Mrs. Chas. Candler	315 N. Perry St., St. Mary's, Ohio	8NH
--------------------	------------------------------------	-----

#### Ninth District

Only one license issued up to going to press:

F. H. Schnell	2220 Roscoe St., Chicago	9AH
---------------	--------------------------	-----

Temporary authorization pending receipt of new license:

R. H. G. Mathews	1316 Carmen Ave., Chicago	9ZN
------------------	---------------------------	-----

### NEWSDEALERS:

We make our own distribution of QST, and will be pleased to supply you direct, allowing credit for unsold copies returned in their entirety at your expense. Give us a small standing order and watch it grow.

### QST BOOSTERS:

Show this to your favorite dealer and get him to send in his order; then tell all the fellows where they can get QST.

## AMERICAN RADIO RELAY LEAGUE,

63 Waverly Bldg.,

HARTFORD, CONN.

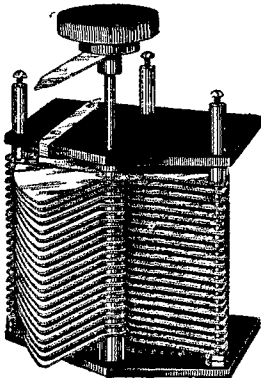

No. 43—.001 m.f. \$4.75.

**A. R. R. L. OPERATORS—THE VARIABLE CONDENSER** you have been looking for—at a price you can afford to pay. The best of materials and workmanship—and look at the prices. Bakelite-Dilecto End Plates—heavy aluminum plates—accurately machined spacers—assembled with care and fully guaranteed. Copper ribbon connection to movable plates which are adjusted to stay in position—but operates smoothly in any position without counterweight.

Complete as shown—PRICES.—include postage for one pound.

No. 2—2 Plate Vernier.....	\$1.85
No. 7—7 Plate .0001 m.f. maximum capacity....	2.15
No. 13—13 Plate .0002 m.f. " ".....	2.50
No. 17—17 Plate .0003 m.f. " ".....	2.85
No. 23—23 Plate .0005 m.f. " ".....	3.25
No. 31—31 Plate .0007 m.f. " ".....	3.90
No. 43—43 Plate .0010 m.f. " ".....	4.75
No. 63—63 Plate .0015 m.f. " ".....	6.75

Specify Thickness of Panel and whether Brass or Nickle Screws and Pointer.

### THE WIRELESS SHOP

A. J. EDGCOMB.

511 West Washington St.,

Los Angeles, California.

# POSITIONS GUARANTEED

To Every Graduate of Our School  
By Four Largest Radio Concerns

**\$125 PER MONTH PLUS ALL EXPENSES**

Modern Equipment      Special Short Course  
Individual Instruction  
Finest Staff of Teachers Available

DORMITORY — SWIMMING POOL

Call or Write for Illustrated Booklet

**Y. M. C. A. RADIO SCHOOL**  
DEPT. R

153 EAST 86TH ST.

NEW YORK, N. Y.

**"BEST RADIO SCHOOL IN THE EAST"**

# Initial Offering

# REMLER RADIO APPARATUS

**Highest Quality at Quantity Prices**  
**IMMEDIATE SHIPMENTS**

**Full Line Switches, Levers, Contacts, Binding Posts, etc.**

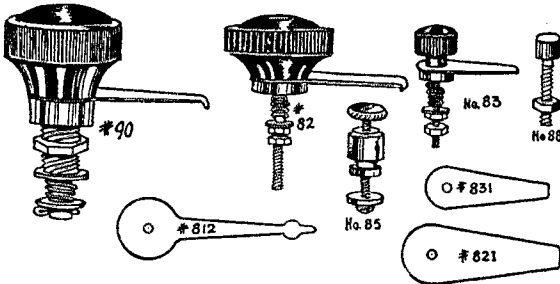

Build your own apparatus and save money. Send for list of parts.  $\frac{1}{4}'' \times \frac{1}{4}''$  or  $\frac{1}{4}'' \times \frac{1}{8}''$  contacts,  $\frac{3}{8}''$  6/32 stud and nut. Heavy polished nickel. Each 6c—per dozen 60c. No. 90 switch. Entirely new. Full  $\frac{1}{4}''$  steel bearing. Lever pinned on. Can never work loose. Large moulded knob, brass bearing, all metal parts polished nickel. Ideal for couplers, panels, loading coils, etc. Price, \$1.25 each

### Remler Panel Type Rheostat

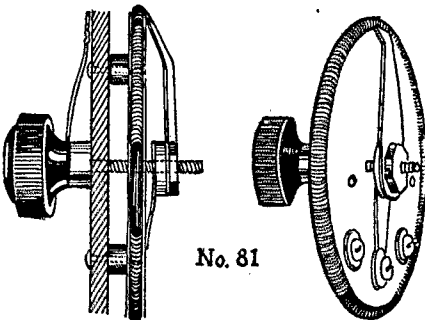

The smoothest running rheostat on the market. Will increase efficiency of your tube control. Resistance mounted on bakelite ring. Unit cheaply renewed. All metal parts nicked. Complete.....\$1.75 each

### Full Line Crystal Detectors

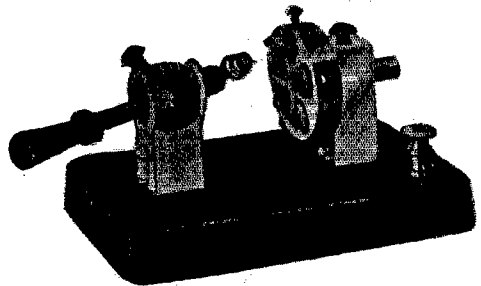

Four models. Mounted on moulded bakelite bases. Prices 95c to \$4.00. Cut shows \$4.00 model. All metal parts polished nickel. Turret head for 5 crystals. Send for bulletin.

### Coupler and Tuner Parts

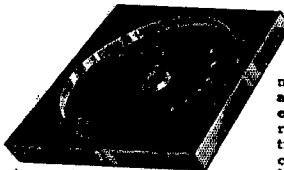

Complete sets of parts or individual items sold. Save money and build your own apparatus. Cut shows moulded bakelite secondary tuning or loading coil end. Cast in bosses for runner rods, switch and tie rod. Drill marks for contacts and binding posts. Two sizes.

$3\frac{3}{4}'' \times 3\frac{3}{4}'' \times \frac{1}{8}''$  to fit  $3\frac{1}{4}''$  tubing. Undrilled, 65c each.  
 $4\frac{1}{2}'' \times 4\frac{1}{2}'' \times \frac{3}{8}''$  to fit  $3\frac{3}{4}''$  tubing. Marked for 11 contacts, 90c each.

Send for complete parts bulletin.

**Terms and Guaranty:** All our apparatus subject to return and full credit if you are not fully satisfied. That is our confidence in the values we offer. All purchases delivered free when cash accompanies order.

### Complete Line of Couplers

Six different types. Wave lengths 1,500 to 15,000. Full navy and slider types. Parts sold if you want to build your own coupler. Price .....\$6.15 to \$35.00

Send for coupler circular

**DEALERS:--We want reliable representatives. Send for full details.**

**REMLER RADIO MFG. CO., 62 Post St., San Francisco, Calif.**

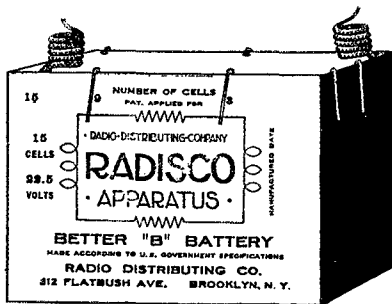

## BETTER "B" BATTERY

The RADISCO BETTER "B" is guaranteed to be manufactured in accordance with U. S. Government specifications and is sold on a money back basis. Among the many reasons it is better are:

### VARIABLE VOLTAGE

This feature alone (on which a patent has been applied for), makes the RADISCO BETTER "B" the battery you will eventually buy. Considerable has been written about vacuum tubes that do not require critical voltage regulation, but the fact still remains that the vacuum tube used by the majority of experimenters requires plate voltage regulation. To provide this regulation, taps have been taken off the 1st, 2d, 3d, 6th, 9th, and 12th cells, (see illustration) and it is only necessary to connect these to a switch to provide critical voltage regulation for your tube.

### ECONOMY

With the ordinary 15 cell battery, when one cell goes "bad," the entire battery must be discarded. With the RADISCO BETTER "B" you only need test each group of three cells, and short circuit the group containing the "bad" cell.

### LOW PRICE

The price of the BETTER "B" is the lowest at which it is possible to sell a first class 15 cell battery.

BETTER "B" No. 1,  
Size 3 1/4 x 2 x 2 1/2 inches, \$1.15  
Postpaid 1.25

BETTER "B" No. 5,  
Size 6 1/2 x 4 x 3 inches, \$2.25  
Postpaid 2.60

# RADISCO AGENCIES

The BETTER "B" battery is only one of the many articles of standard radio apparatus carried by RADISCO AGENCIES. These Agencies are the leaders in the Radio Field in their locality. It will pay you to communicate your wants to them.

**ATLANTIC CITY, N. J.**  
Independent Radio Supply  
118 So. New Jersey Ave.

**BIENVILLE, QUE., CANADA.**  
Canadian Radio Mfg. Co.

**BOSTON, MASS.**  
Atlantic Radio Company  
34 Battery March St.

**BROOKLYN, N. Y.**  
Kelly & Phillips  
Flatbush Ave. near 7th.

**CHICAGO, ILL.**  
Chicago Radio Laboratory  
1316 Carmen Ave.

**NEWARK, N. J.**  
A. H. Corwin & Co.  
4 W. Park St.  
(Note new address)

**NEW ORLEANS, LA.**  
L. A. Rose  
4323 Magnolia St.

**ALBANY, N. Y.**  
E. L. Long  
21 Magnolia Terrace.

**PROVIDENCE, R. I.**  
Rhode Island Elec. Equip. Co.,  
45 Washington St.

If none of the above agencies are in your vicinity communicate direct with the

**RADIO DISTRIBUTING CO.**  
312 Flatbush Ave., BROOKLYN, N. Y.



# G. A. STANDARDIZED SUPPLIES

## G. A. STANDARDIZED B BATTERIES, 22.5 VOLTS

Built to specifications of U. S. Signal Corps and Bureau of Steam Engineering. Made by the formula used for 90% of the B batteries by the Government. G. A. batteries last longer and are cheaper than flashlight cells. Made for V.T.'s. and Audiotrons. Need no voltage adjustment tho they can be used with a potentiometer. Two Navy type batteries with one V.T. will transmit 2 to 5 miles telephone, or 4 to 10 miles telegraph. Three or four will give much greater range.

**SIGNAL CORPS TYPE**, 3 1/4" long, 2" wide, 2 1/4" high, operates one V.T. 250 hours continually, average life 3 months, \$1.60 prepaid.  
**NAVY TYPE**, 6 1/4" long, 4" wide, 3" high, operates one V.T. 1,000 hours continually, average life 10 months, \$2.65 prepaid.

## G. A. STANDARD H. F. CABLE FOR RECEIVERS AND V. T. TRANSMITTERS

10 No. 38 cable, D.S. covered, for receiving coils. Good for 2-bank winding. 40 turns per inch. Price per 100 feet \$0.50  
20 No. 38 cable, D.S. covered. Gives greater signal strength and sharper tuning than solid wire. 35 turns per in., 100 feet \$0.85  
3 x 16 No. 38 cable, D.S. covered. Must be used for V.T. transmitting inductances for maximum efficiency 17 t.p.i., 100 feet \$1.60

## G. A. LITE MOISTURE PROOF TUBING FOR INDUCTANCES

A new material which reduces high frequency losses, does not absorb moisture, is superior to more expensive tubing. Sold in 12-inch lengths. Intended specially for V.T. transmitting coils, 1/8" thick. 3" o.d. 30c, 3 1/2" 36c, 5" 40c, 5 1/2" 50c.

## SEND 3c STAMP FOR THE G. A. INTRODUCTORY BULLETIN

All kinds of needed supplies are listed in the Introductory Bulletin, magnet wire, Bakelite panels for Standardized Panel Construction, wood screws, machine screws, nuts, edgewise copper strip, antenna wire, high tension cable, and other supplies for radio, model, and general experimental work. Everything kept in stock, no delays on substitutions for G. A. customers. Postage prepaid east of the Mississippi River. No orders less than One Dollar.

G. A. SUPPLIES ARE SOLD BY MAIL ONLY. NO GOODS SOLD AT THE NEW YORK OFFICE.

MONEY BACK  
GUARANTEE ON  
EVERY ORDER



QUICK SERVICE  
ABSOLUTE  
RELIABILITY

## The General Apparatus Company

158 East 18th Street,

New York City

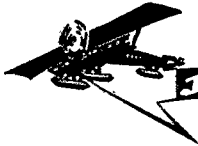

# EASTERN RADIO

# INSTITUTE

899 BOYLSTON ST.  
BOSTON, MASS.

# RADIO

TEL.  
BANK BAY  
5964



# ANNOUNCEMENT!

One of the largest Wireless Telegraph Companies in the country, operating hundreds of ships to all parts of the world, has GUARANTEED to place in good positions EVERY MAN who graduates from the EASTERN RADIO INSTITUTE. We are POSITIVELY the ONLY school in New England who can make this statement and guarantee every man a position. When you realize that it only takes six months in the Day School or nine months in the Evening school to accomplish the work and that the salaries for beginners are from \$100 to \$125 per month, food and quarters included, and that the entire expense of the course can be returned to you in one month's salary, doesn't this appeal to you? Remember we are the OLDEST, LARGEST, and BEST EQUIPPED telegraph school and have THOUSANDS of satisfied graduates to our credit. THIS SPEAKS FOR ITSELF. Day And Evening Classes. Start any Monday. Other courses for Men and Women in Commercial, Railroad and Brokerage telegraphy. Special afternoon and Saturday classes for Amateurs now forming. Our prospectus for the asking.

**ATTEND  
MASSACHUSETTS RADIO AND TELEGRAPH  
SCHOOL**

**18 BOYLSTON STREET, BOSTON**

For Instruction in Radio and Telegraphy. Day and Evening  
Classes now in Session.

Students may begin course any Monday. Free Amateur Class  
Saturdays, 10 A.M.

**500-CYCLE SET RECENTLY INSTALLED.**

Tel. Beach Beach 7168

## RADIO MEN!

Make your Apparatus Up-To-Date

## INDICATING DIALS

AT A REASONABLE PRICE ARE NOW  
AVAILABLE

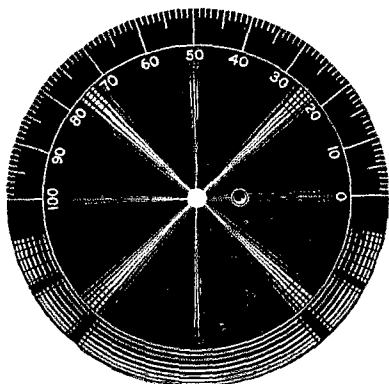

**3" DIAL INDICATOR**

3" DIAL ONLY, POST PAID \$0.75  
3" DIAL WITH BAKELITE KNOB,  
WITH SET SCREW POST PAID \$1.30

BULLETIN No. 1 describing these Dials  
has been sent to all who sent for our  
catalog. If you have not received our  
catalog send 5c in stamps for it and  
get on our mailing list for future  
bulletins free.

These Dials are fine black polished composition  
with radial lines and numerals accurately en-  
graved and filled with brilliant white. DIALS  
are 3 inches in diameter and 3-16" thick. The  
edges are bevelled. Hole in center will pass  
8-32 and there are 3 holes around the center  
hole to fasten on Knob. (These holes are not  
shown in cut.) We can furnish Dial alone or  
with fine Bakelite Knob Mounted. This Knob  
has a set screw to clamp shaft of instrument to  
which Dial is applied.

If your dealer cannot supply you send us your  
order with his name. Immediate deliveries.

FOR SALE AT ALL RADISCO AGENCIES

## A. H. CORWIN & CO.

4 WEST PARK STREET

NEWARK, N. J.

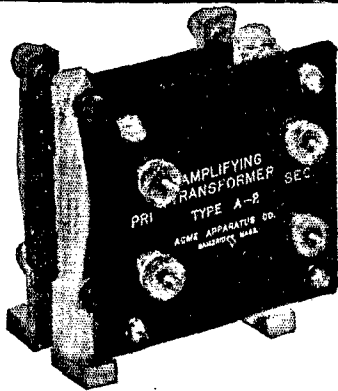

### CHANGE OF PRICES

With Quantity Production and adoption of Automati-  
cally Wound Coils, we are glad to announce a Re-  
duction in prices of our Amplifying Transformers as  
follows:

Type A-2 Fully mounted with Aluminum Supports,  
Engraved Bakelite Dilecto Panel, and Nickel Plated  
Bind Posts.....\$7.00  
With Supports, but without Panel and Bind  
Posts.....\$5.00

Assembled, but Unmounted.....\$4.50  
Although originally designed for use with VT-1 Tubes,  
these are now being used extensively and with excel-  
lent results with Marconi V.Ts.

**ACME APPARATUS CO.**

28 WINDSOR ST.,

CAMBRIDGE, MASS.

# LONG DISTANCE TRANSMISSION

Can be accomplished only by the use of an efficient rotary gap.

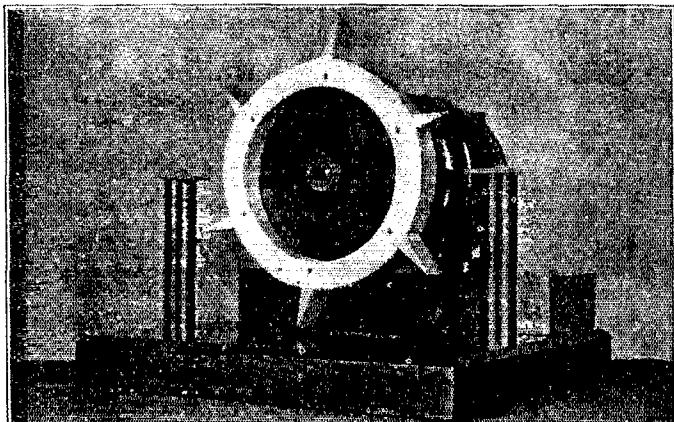

Our HY-RAD Rotary Gap, illustrated above, combines substantial mechanical construction with the highest electrical efficiency.

Gives excellent quenching.

Disc measures 9 inches diameter and 1 inch thick, made of aluminum Disc mounted on bakelite center and is carefully balanced and will run absolutely true. Bakelite stationary electrode supports.

Made with either 8 or 10 teeth, as desired

HY-Rad Gap, Complete, with best quality 1/10 H.P. 3400 R.P.M. Induction motor mounted on finished base,.....\$27.50  
Disc only.....10.00

Write for Bulletin J-19 of high grade receiving apparatus.

**CHICAGO RADIO LABORATORY 1316 Carmen Ave., Chicago, Ill.**

# SPECIAL OFFER

For month of November only we will supply all switch points complete with either brass screw or 1/4" hex brass nut at prices listed below

## SWITCH POINTS



626



628

627

	Doz.	50	100
No. 626—1/4" dia. x 3/4" high, tapped 6-32	\$0.30	\$1.00	\$1.75
No. 627—1/4" dia. x 1/4" high, 1/2" shank 6-32	.36	1.25	2.00
No. 628—1/4" dia. x 1/4" high, tapped 6-32	.30	.90	1.50

Above prices plain brass finish. Nickel points 50% advance.



602

## KNOBS

	Each	Doz.
No. 602—1" dia., 8-32 bushing	\$0.10	\$1.00
No. 606—1 1/4" dia., 13-16" high	.20	2.00



606

POSTAGE ON ALL ABOVE PARTS EXTRA.

We are agents for all the Reliable and only the reliable Wireless Manufacturers. Send us your orders and inquiries for any apparatus made by C. Brandes, Inc., J. H. Bunnell & Co., Clapp-Eastham Co., DeForest Radio Tel. & Tel. Co., A. H. Grebe & Co., Wm. J. Murdock Co., Thordarson Elect. Mfg. Co., and others. We will give you prompt attention.

SEND TODAY FOR OUR CIRCULAR G SHOWING COMPLETE LINE

**SHOTTON RADIO MFG. CO., P.O. Box 3, Scranton, Pa.**

BRANCH: 8 Kingsbury St., JAMESTOWN, N. Y.

# BAN OFF

ON OCTOBER 1ST THE NAVY DEPARTMENT REMOVED THE BAN ON AMATEUR TRANSMITTERS. WHO WILL BE THE FIRST A. R. R. L. AMATEUR TO TRANSMIT

## 1500 MILES ON 200 METERS

AND WIN THE THORDARSON PRIZE? GET BUSY—  
OTHERS ARE TRANSMITTING NOW.

As an award to the first A. R. R. L. amateur transmitting 1500 miles on 200 meters and complying with the conditions as outlined in the August QST, we are going to give the winner one of these new 1 K. V. A. 25,000 volt wireless transformers or \$35.00 in cash. Our T-20 catalog mailed on request.

IN A  
CLASS  
BY  
ITSELF

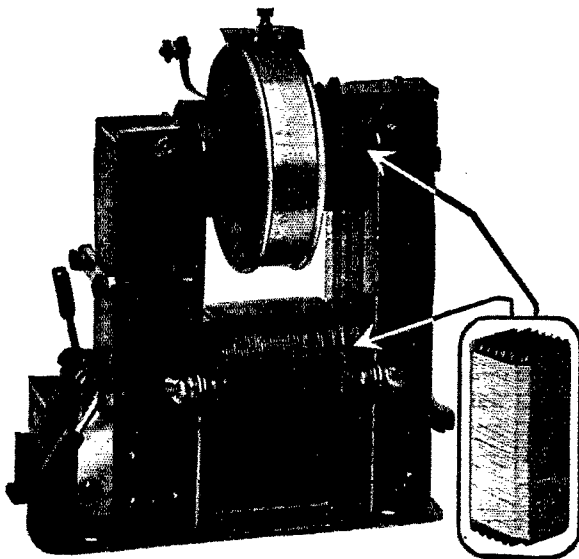

ALWAYS  
ON TOP  
AND  
SECOND  
TO  
NONE

WRITE FOR OUR CATALOG T-20

## THORDARSON ELECTRIC MFG. CO.

501 S. JEFFERSON STREET

CHICAGO, ILL.

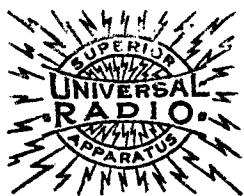

# UNIVERSAL SYSTEM RADIO APPARATUS

*Efficient equipment for all purposes*

*Damped and continuous waves*

*Send stamp for Catalog and mention QST*

Universal Radio Mfg. Corporation  
ELMIRA, N. Y.

## WIRELESS TELEGRAPHY PAYS BIG MONEY

We Teach You in Two to  
Three Months

There is a great shortage of wireless telegraphers, due to enormously increased demand. Ships cannot or will not leave port without wireless operators; the pay is high; advancement rapid; the hours are short—it's worth while. Write for catalog—learn how quickly and easily you can qualify for positions paying

**\$125.00 PER MONTH INCLUDING FOOD AND QUARTERS AND TRANSPORTATION TO PORT**

Our scientific system of teaching wireless telegraphy perfected by a corps of practical experts, makes you fully competent in two to three months. Wireless is easy to learn—the cost is low and the result is certain. Hundreds of our graduates are profitably employed and are doing duty and seeing the sights in every port of the world. This is your opportunity.

We put you in touch with the position you want. Write today for catalog. It explains all fully. Our course is recognized and endorsed by United States Government Officials. Our course in Railroad, Commercial and Brokerage Telegraphy may interest you. Taught in TWO to FOUR MONTHS, by phonographic system in your own home in spare time. Big pay—Big demand—Write today.

CHICAGO TELEGRAPH INSTITUTE  
America's Finest School  
3412 Michigan Ave., Chicago.

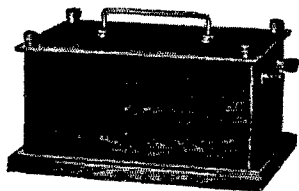

## NEW HI-VOLT STORAGE BATTERY

A new development in vacuum tube reception has been made in this New Hi-Volt Storage Battery. The feature is a self-contained battery and rectifier. The battery has a voltage of 24 and under normal use holds its charge for three weeks. When discharged all you do is to connect a 110 volts A.C. line and in three hours the battery is fully charged and ready for use.

**Economical---Efficient---Lasting**

Combined Battery and Charging Rectifier  
as Illustrated, \$15.00

Send 6c. for our catalog No. 1  
and description of Hi-Volt Storage Battery.

**The C. D. Tuska Company**  
HARTFORD, CONNECTICUT

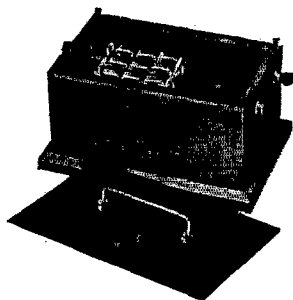

# Federal Audio-Frequency Transformer

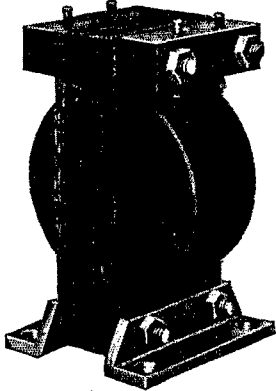

The No. 226-W  
Price \$7.10

The only Audio-Frequency Transformer designed for use with the Marconi V. T. Class I and II and approved by expert engineers.

WONDERFUL RESULTS ARE OBTAINED  
IN AMPLIFICATION BY IT

All who have a Marconi tube, or one of same internal impedance, should have a FEDERAL No. 226-W, Type A, in order to get high class results.

WRITE FOR BULLETIN 102-W

We also furnish the Marconi Tubes, Standard Mountings and Leak Resistances, at regular prices.

**Federal Telephone and Telegraph Co.      BUFFALO, N. Y.**

MANUFACTURERS OF  
STANDARD AIR CORE AUDIO-FREQUENCY TRANSFORMERS. "LIBERTY" HEAD TELEPHONES. FAMOUS "CENTURY" HIGH-FREQUENCY BUZZERS. THE ORIGINAL ANTI-CAPACITY SWITCH. STANDARD PLUGS, JACKS AND ACCESSORIES.

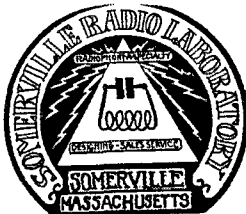

102 HEATH ST.

## Be Patient

We use care in designing our SORALA RADIO SPECIALTIES SIMPLICITY which we feature makes for EFFICIENCY as well as REASONABLE PRICES. Send 4 cents for Bulletin out next month.

SORALA VT sockets, \$1.25 each, 5 for \$5.00; Ready now. All Bakelite non-moulded construction with ample connectors and phosphor-bronze spring contacts. SORALA Grid Leak Attachment, \$0.25 additional. SORALA VT amplifiers (unassembled) \$12.00 per step. A reasonably priced tube transmitter, ready soon.

## The Oldest Radio Supply House in New England

Agents for all reliable lines of apparatus

**GEO. S. SAUNDERS CO.**

168 Washington St.      11 Devonshire St.  
BOSTON, MASS.

## LEARN WIRELESS TELEGRAPHY

*Fascinating and Educational Work—Big Salaries—Prepare Now*  
The United States Shipping Board is making heavy demands upon us for **Dodge-trained** wireless operators. Travel all over the world, secure, free, unsurpassed living accommodations and earn a big salary.

**We Also Teach Morse (Wire) Telegraphy and Railway Accounting**  
School established 45 years. Endorsed by wireless, railway and telegraph officials. Low rates. Students can earn living expenses while attending school. **Catalog Free. Write Today,**  
**Dodge's Telegraph and Wireless Institute      27th St.      Valparaiso, Indiana**

## CAN WE SEND YOU A GENUINE TWO FILAMENT AUDIO TRON BULB C. O. D. \$4.50—No Other Charge

We were the first to sell the AUDIO-TRON. Our standing guarantee is that the bulb is sensitive as a detector, a powerful amplifier and oscillator. We have had no "comebacks" against our bulbs during the past four years. Can we send you interesting literature?

**JENSEN ELECTRIC COMPANY, 1949 Huron Street, CHICAGO ILL.**

## CLASSIFIED ADVERTISEMENTS

Five cents per word per insertion, in advance. Copy must be received by the 10th of month for succeeding month's issue.

**TELEGRAPHY** (both Morse and Wireless) AND **RAILWAY ACCOUNTING** taught thoroughly and quickly. Big salaries now paid. Great opportunities. Oldest and Largest School—est. 45 years. Catalog free. Dodge Institute, 28th St., Valparaiso, Ind.

**WANTED**—An Omnigraph, Continental discs. Post Office Box 629, Hartford, Conn.

**MOTOR-GENERATOR** 110 D. C. to 60 V. A. C. 1/6 Kw. Starter and Clapp-Eastham transformer. Range 100 miles, \$45. Particulars and photograph 10 cents in stamps. E. G. Baier, 253 Ninth St., Brooklyn, N. Y.

**FOR SALE**—1 K.W. Thordarson and 1 K.W. Blitzen trans. Perfect condition. First good offer takes them. M. Frye, Jr., Box 187, Vineland, N. J.

**FOR SALE**—Mesco 3" spark coil; Murdock Oscillation transformer and aerial switch. Bargain. E. Cyriax, 219 East 71 Street, New York City.

**Amplifier Units**, two step \$15. **Amplifier Coils** \$6. Send stamp for circular. Radio Sales Co., 1629 McAllister Street, San Francisco, Calif.

**FOR SALE**—1/2 K.W. Packard Transformer. Gray, 443 Northampton, Easton, Pa.

**FOR SALE**—Old 9GY Equipment; write for list. L. Armstrong Kern, 1503 Cambridge Road, Ann Arbor, Michigan.

Antennas built and erected. Masts put up. All kinds of Antennae construction work done. Will go anywhere in New England. Saturday afternoons and Sundays preferred. J. Limone, 53 Granville Ave., Medford, Mass.

**FOR SALE**: Mignon Undamped Receiving Set RW3, cost \$100.00, sell \$60.00, A1 condition. Theodore Olson, 528 Market St., Portland, Oreg.

**FOR SALE**—Undamped Receiving Apparatus, Cheap, Write. G. L. Brewer, Big Pool, Maryland.

**NEW**: Moorhead-Marconi Tubes \$6.25, Army "B" Batteries \$0.98 prepaid; Apparatus at reduced prices. Natush, 145 West 55 Street, New York City.

**WANTED**: Guns, Apparatus, Sock, Box 101, Stockbridge, Mass.

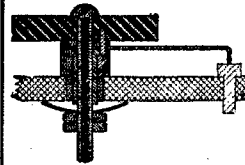

THE WILCOX LABORATORIES

**WILCOX  
PANEL SWITCH  
"The Best"**  
1 1/4" Radius Postpaid  
Pol. brass fin. switch 50c  
Nickle pl. fin. switch 60c  
Turned and pol. knob 25c  
Brass switch points 2c  
Nickle pl. switch pts. 4c  
Lansing, Mich.

### EUGENE C. BROWN

PATENT LAWYER

Electrical Engineer, Lehigh Univ.  
Former Examiner Elec. Div. U. S. Patent Office

**PATENTS AND PATENT LITIGATION**

734 Eighth St., N.W. WASHINGTON, D. C.

### MR. AMATEUR

**HIGH FREQUENCY CABLE**—(LITZ).  
16-3-38 and 16-2-38 D. S. C. Enameled  
**GREY SEAMLESS CARDBOARD TUBES**  
Bakelite and rubber panels, vacuum tubes. Write  
for circular on Honeycomb Coil Mounting—  
it will interest you. Wholesale and retail.

**A. T. HOVEY**

61 Belvidere Street, Near Mechanics Bldg.,  
BOSTON, MASS. (Open Evenings)

### WIRELESS APPARATUS

We Carry a Full Line of Wireless  
Supplies for the Amateur.

**JAMES W. POOLE, Inc.**

64 Kingston St., Cor. Bedford  
Boston, Mass.  
Est. 1887.

## NEW ORLEANS WIRELESS SUPPLIES AND MINERALS OF ALL DESCRIPTIONS

**L. A. ROSE**

4323 MAGNOLIA STREET

NEW ORLEANS, LA.

SEND 6 CENTS FOR CATALOG

## PAPER TUBES

For constructing loose couplers, loading coils, variometers, etc., smooth, round, gray, seamless, tubes.

### FOR 3500 METER COUPLER

Primary 3 3/4" outside dia. 7" long—25c  
Secondary 3 1/4" outside dia. 6" long—20c

### FOR VARIOMETERS

Primary 4 3/4" outside dia. 2 1/2" long—12c  
Secondary 3 3/4" outside dia. 2" long—10c

### FOR LOADING COILS

3 3/4" Outside Dia. 14" long—40c

4 1/4" Outside Dia. 14" long—50c

Special Lengths Cut to Order

To 15" long 3 1/4" dia.—4c per in.

3 3/4" dia.—5c per in.; 4 1/4" dia.—6c per in.

All tubes have 1/8" wall.

IMMEDIATE SHIPMENTS, POSTPAID.

**THE TAYLOR COMPANY, BOX 1043C,**

**LOWELL, MASS.**

## Laboratory Signs

Attractive 8" x 10" signs printed on high quality coated white cardboard in selected wordings for the electrical experimenter.

1. DANGER! HIGH VOLTAGE
2. EXPERIMENTAL RADIO LABORATORY  
NO ADMITTANCE
3. GOVERNMENT LICENSED RADIO  
STATION
4. DO NOT TOUCH THE INSTRUMENTS
5. PLEASE BE QUIET WHILE THE  
OPERATOR IS RECEIVING

15c EACH, ANY TWO FOR 25c

ALL 5 FOR 50c

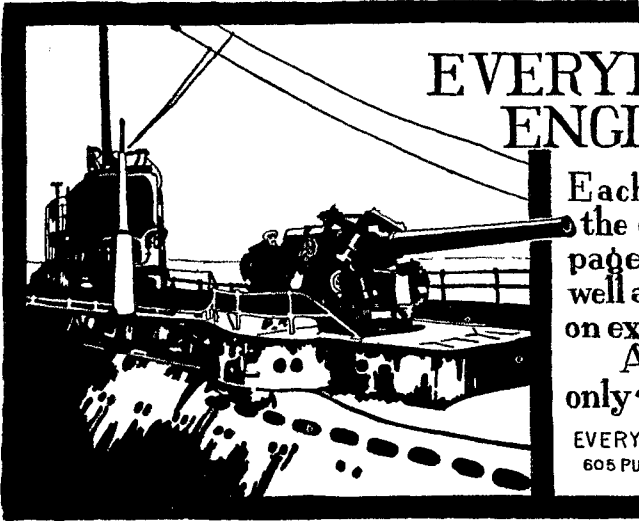

# EVERYDAY ENGINEERING

Each month contains the equivalent of a 60 page book on radio as well as a fund of articles on experimental work. And the price is only ~Fifteen cents.

EVERYDAY ENGINEERING MAGAZINE  
605 PUTNAM BLDG, 45th ST., NEW YORK

## SWITCH CONTACT POINTS

Very Accurately Machined from Brass  
Heads  $\frac{1}{4}$ " Dia. x .150" high—Shank, 8-32 thread x  $\frac{3}{8}$ "

### —PRICES—

Polished Brass—ea. 2 $\frac{1}{2}$ c.—30c. doz.

Polished Nickle—ea. 4c.—48c. doz.

## BRASS BINDING POSTS

A good post at a low price of 10c. ea.

polished nickle plate at 15c. ea.

Large Lathe Turned Knobs—8-32 thread—20c.

Send for new Circular on Parts and Instruments.

## THE WIRELESS SHOP

511 West Washington St.,

Los Angeles, Cal.

## THE "RVA" BULLETIN

Published Each Month  
Tells How Responsible Amateurs Can Purchase

# RADIO APPARATUS

on the

# INSTALMENT PLAN

Ten Cents brings a Loose Leaf Binder and the RVA BULLETIN each Month

J. DONALD VANDERCOOK  
PARKSIDE AVE., LOMBARD, ILL.

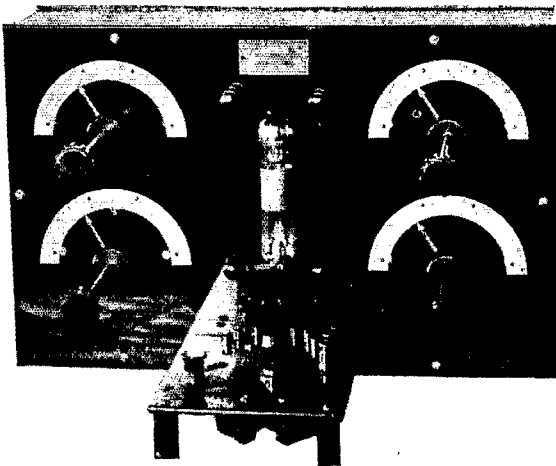

## "COS-RADIO"

Mark of Quality

Our Variable-Tron Set

"A Thing of Beauty"

Four Variables and complete Tron  
Equipment. Highly Efficient

Do You Hear POZ?

Our Long Wave Receiving  
Cabinet Does It.

Get Our Prices

Everything Radio

WATKINS MFG. CO.

Wichita,

Kansas



# AERIAL WIRE

7 strands of No. 22 Copper High Tensile strength and 100% conductivity. Supply limited at this price. Shipping weight about 15 lbs. per 1000 ft. Postage extra No C. O. D.'s. at this low price.

**1 CENT PER FOOT**  
\$9.00 Per Thousand

Genuine 2 Filament Audiotrons  
Guaranteed Super-Sensitive

**\$5.00** POSTPAID  
INSURED

**LEE A. BATES**

8 Moen Street, Worcester, Mass.

## THE RADIO ELECTRIC CO.

Special B battery 22 V 5 Amps \$1.15, Audiotron detector tubes \$5.00 postpaid and insured. Grid leaks, condensers and all vacuum tube supplies.

**CONCENTRATE YOUR BUYING** by purchasing all of your equipment through us. We handle all reliable standard instruments, including Baldwin receivers, DeForest apparatus, Grebe's latest developments and many others of the same grade.

## RADIO ELECTRIC CO.

4614 HENRY ST. PITTSBURG, PA.

## Audiotron B-Batteries

30 cell 45 volt batteries will outlast three set of flashlight cells. Taps brought out for six different voltages.

**\$5.50**

Postage, \$0.10

Prices on other Apparatus upon Request.

**F. C. MYERS**

45 Albany Trust Co. Bldg., Albany N. Y.

## Radio Apparatus

Phones	Knobs
Condensers	Formica
Inductances	Contact Points
Rheostats	Binding Posts
Switches	Copper Strip
Vacuum Tubes	Aerial Wire

CATALOG \$0.06

**KLAUS, Eureka, Ill.**

Can you beat the Double A Quality Goods?

Short wave regenerative sets, 150-600 meters \$25.00:

Two Step Amplifiers Guaranteed to increase signals 60 Times, Price, \$25.00, without Bulbs.

Audion Control Panels—\$11.75.

All apparatus complete with polished Cherry Cabinets, and Bakelite Panels.

ALL OUR INSTRUMENTS ARE GUARANTEED

NOTE—Prices of our products as advertised in October QST are effective until November 15th only.

We advise operators to place their orders early, to insure early delivery; and avoid increasing costs; these prices are effective until DECEMBER 15th.

**RADIO EQUIPMENT COMPANY**

1525 North Fawn Street, Philadelphia

## 8,000 MILES

is the record (amateur) with our Audio-Tron Detector.

**THE GENUINE AUDIO-TRON DETECTOR - AMPLIFIER - OSCILLATOR**  
Price postpaid \$4.50

Can we send you one C. O. D. ?  
No extra charge.

**Jensen Electric Co.**

RADIO APPARATUS

1949 Huron Street CHICAGO, ILL.  
TWO FILAMENT BULBS ONLY

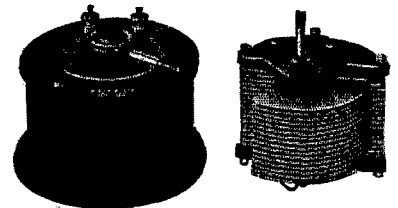

## Variable Air Condenser

TYPE 182

A high grade condenser with plates designed to give approximately even variation of wavelength throughout the scale.

Made in two sizes: .0007 M. F. at \$10.00 and .001 M.F. at \$13.00.

Full data on request.

**General Radio Co.**

WINDSOR STREET

CAMBRIDGE

MASS.

"ASK ANYONE WHO HAS USED IT"  
**"THE BEST  
 I EVER WORKED"**

"The Brandes Headset Is The Best I Ever Worked. Others Look Like a Plaything Beside It." (Testimonial from an expert. Name on request.)

Professionals and Amateurs the world over are enthusiastic about the range and absence of blurring in the



**BRANDES  
 WIRELESS  
 HEADSET**

'Superior' 2000 ohms \$7

**TRIAL OFFER** Test out Brandes Wireless Receivers against any other make. Test them for sensitiveness, clearness and distance. If within ten days you're not only satisfied but enthusiastic over them—back comes your money without a question.

Prove for yourself the fine quality, the "matched tone." The two diaphragms, toned exactly alike, strengthen the signals and prevent blurring. Used by many U. S. Gov't experts, and experts abroad; by colleges and technical schools; and by professionals and amateurs everywhere.

SEND 4c. FOR CATALOGUE F

**C. BRANDES, Inc.**

Room 821, 32 Union Square, New York  
 WIRELESS RECEIVER SPECIALISTS

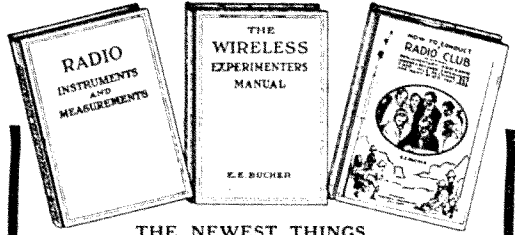

THE NEWEST THINGS  
**IN WIRELESS**  
 ARE IN THESE THREE BOOKS  
 Just Off the Press

**RADIO INSTRUMENTS AND MEASUREMENTS**  
 Every amateur should have this book as it answers the questions you want to ask and covers all phases of the subject matter indicated by its title. Cloth Bound, 320 Pages, \$1.25.

**THE WIRELESS EXPERIMENTERS' MANUAL**  
 By E. E. Bucher. Mr. Bucher's latest book. The only one that comprehensively covers all phases of wireless work, including the latest practices in both Radio Telegraphy and Telephony. Most complete text book on these subjects yet published. Cloth Bound. Approximately 300 Pages. Price \$1.75.

**HOW TO CONDUCT A RADIO CLUB**  
 By E. E. Bucher. One of the most popular wireless books ever published. Covers parliamentary procedure, indoor and outdoor experiments, 5,000-mile receiving sets, use of vacuum tubes and many other subjects. Paper Cov. 148pp., 50c.

**THE WIRELESS AGE**  
 A monthly magazine that will keep you posted on the up-to-the-minute things in wireless communication. Official organ of the National Amateur Wireless Ass'n. Price Per Year \$2.00. SPECIAL COMBINATION PRICE. ALL FOUR ONLY \$4.50

**WIRELESS PRESS**

1852 Woolworth Building, New York

"Send for latest catalog"

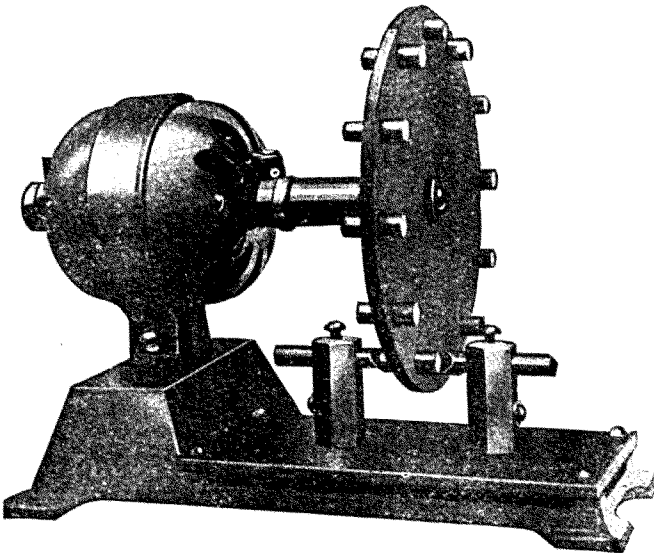

**KLITZEN  
 ROTARY  
 SPARK GAP**

Federal Law requires a rotary spark gap in every transmitting station. When you buy a KLITZEN you get the most efficient non-synchronous gap. 3 inch current travel. Balanced disc—absolutely true—no wobble or vibration. Renewable Spark Points. Highest grade, universal motor—operates on 110-120 volts A. C. or D. C. 25-60 cycles. Speed with Disc 4000 R.P.M.—quick pick up—practically noiseless.

ORDER AT ONCE.

PRICE \$22.00

Shipping Weight 8 lbs.

**Klitzen Radio Manufacturing Co.**

1501 Flett Ave.,

Racine, Wis.

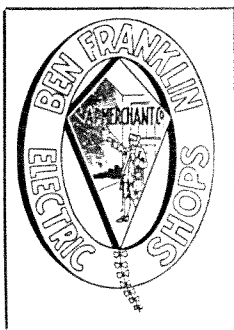

# RADIO EXPERTS

*The Amateur or the Professional can depend upon our advice.*

*It means "short cuts" and the best of results with your apparatus.*

*This service is absolutely free.*

*Everything in Radio Apparatus from the "Tower to the Key."*

## A. P. Merchant Co.

9 AVERY STREET

BOSTON

# RADIO APPARATUS

Distributors of All Prominent Makes:—

DeForest, Grebe, Murdock, Wireless Specialty, General Radio, Clapp-Eastham, Brandes, Acme, Audiotron Sales, Federal Tel. and Tel. etc., etc. You can place your orders right from their catalogs and secure immediate delivery.

**LARGEST AND BEST STOCK OF ANY HOUSE IN NEW ENGLAND.**

SHORT-WAVE REGENERATIVE RECEIVER

TYPE CR-2

Wave-length range: 170 to 600 meters

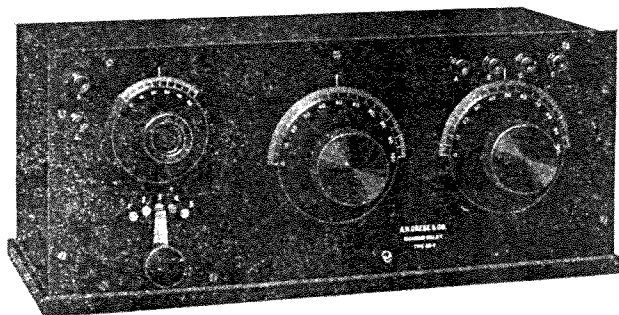

Shipping weight 21 pounds.

PRICE \$46.00

**EXCLUSIVE DISTRIBUTOR OF GREBE PRODUCTS IN NEW ENGLAND.**

For real prompt delivery send us your orders for honey-comb coils, Unit panels, all kinds of vacuum tubes, all makes of telephones, radio textbooks, amplifiers, control panels, etc. etc. Remember this material is carried right in stock and shipped the same day as order is received. GIVE US A TRIAL.

**F. D. PITTS CO., Incorporated**  
 12 Park Square, Dept. A, BOSTON, MASS.

# EVERYTHING FOR AN IDEAL AERIAL

COMPLETE  
OR PARTS

— “CQ — CQ — CQ” —

FOR LAND OR  
MARINE STATIONS

SPARS BRIDLES INSULATORS WIRE — ROPE MASTS	TO	OUR SPECIALITY	Distributors of HIGH GRADE RECEIVING APPARATUS
	AMATEURS	2, 3, 4 & 6 WIRE ANTENNAS for 200 meters; LONG WAVE 2 WIRE RECEIVING ANTENNAS. Galv. All STEEL-PIPE MASTS—Any Height. Construction: Specially designed, turned and perfectly tapered SPARS—fitted with galv. steel mast bands; best grade flexible galv. wire BRIDLES; galv. pulleys; ELECTROSE INSULATORS; seven strands PHOSPHOR BRONZE ANTENNA WIRE; high- grade WEATHER-PROOF HOISTING ROPE. MASTS: Telescopic 24" riveted joints; durable and beautiful; sur-mounted with genuine Gold Leaf covered Ball. "Made in America"	

Prices quoted on application. Specify your particular requirements.

“K-K”

“AT YOUR SERVICE”

“K-K”

NORTH AMERICAN AERIAL SPAR MFG. CO.

Dubuque, Iowa

## “Hear 'Em All”

The ether is free again. Why not make yours one of the stations that are “doing” things? Hear those fellows across the continent. You can bring in piercing signals from them with a

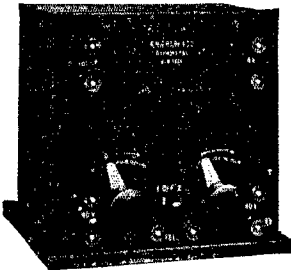

Type ROBB, Price \$45



### Two-Stage Audio-Frequency Amplifier

Designed since the Armistice, this Amplifier embodies the latest engineering achievements. The howling, found in other types, has been eliminated without sacrificing efficiency. The cover is hinged, affording accessibility to all parts. Sockets accommodate the standard 4-prong tube.

The wiring and mechanical construction are characteristic of Grebe workmanship. Better be sure your Amplifier is a Grebe.

Write today for free bulletin describing Grebe Amplifiers;—complete catalog sent upon receipt of 10 cents.

A. H. GREBE & CO., 74 Van Wyck Blvd., Richmond Hill, N. Y.

## The BARR MERCURY-CUP WIRELESS DETECTOR

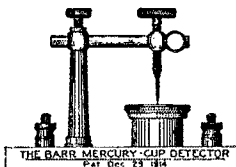

The most efficient Detector on the market. Tested by the United States Government and Marconi Wireless Telegraph Company.

Increases the efficiency of every wireless receiving set by making the signals clear, sharp and distinct.

Instantly adjustable at a constant pressure.

FOR FULL INFORMATION AND PRICE — WRITE

The Barr Mercury-Cup Detector

Dept. E, THE WYOMING,  
WASHINGTON, D. C.

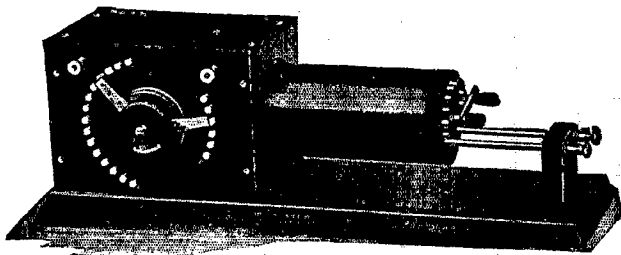

## ARNOLD NAVY MODEL LOOSE COUPLER

Altho this instrument has been before the public for five years, the demand for it is just as persistent; and altho many pre-war standards have been swept away you will find, after much experimentation with new-fangled ideas, that for selectivity and sharpness of tuning you "have to go some" to beat a well-designed Loose Coupler.

The instrument illustrated above is correctly designed, its workmanship the best, and it presents much better value than you expect—if you could see one and operate it, you would expect it to cost more.

For special design binding posts, knobs, switches, rheostats, and in fact better grade accessories, send two-cent stamp for my bulletin.

### J. F. ARNOLD

(Established 1910)

2082 LEXINGTON AVENUE

NEW YORK

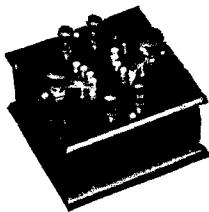

## PERFECTION TUNERS

20,000 meters Long Wave Receiving Tuners, a revolutionary design, equally efficient on loop aerials, overhead, or underground; work on a long aerial as well as a short. XDA comes in on the first tap, NSS on the fourth. The wave length range with .001 M.F. Perfection Condenser is from 3500 to 20,000 meters.

Wiring diagram is on the bottom of each instrument and this one must be followed. No tickler coils are used or needed.

Size of instrument is  $4\frac{3}{4} \times 4\frac{3}{4} \times 2\frac{1}{2}$ , and it will readily set in a deForest panel. The top is of formica—switches and points highly nickle-plated, hard rubber binding posts, and absolutely guaranteed as represented or money will be refunded.

The price of this tuner is \$15.00, delivered to you.

### PERFECTION 200-METER REGENERATIVE TUNER

Same size as above and same weight, with the exception that hook-up shown on bottom is the same as shown in QST, page 5, December, 1916.

Price: \$15.00 delivered to you.

### PERFECTION KNOCK-DOWN VARIABLE CONDENSERS

43-plate—capacity .001 M.F.....	\$2.50
21-plate—capacity .0005 M.F.....	2.25
11-plate—capacity .00025 M.F.....	1.75

Aluminum plates, .0156; fibre tops and bottoms; brass washers, brass dial graduated zero to 180; shipped in a neat box, knocked down—you assemble them yourself—no outside cover, but just as shown in the cut, designed for panel sets; no screws are furnished to fasten this to the panel. The 11-plate is just the thing for the grid; the 43, for the primary; and the 21, for the secondary.

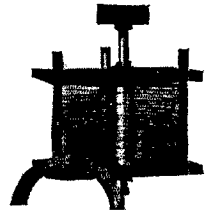

TRESCO, P. O. Box 148, DAVENPORT, IOWA

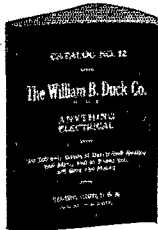

# DUCK'S BIG 300 PP. Wireless and Electrical Catalog

Is now as it always has been, the largest and most complete and dependable Wireless Catalog published. Mailed for 12c. in stamps or coin which may be deducted on first order of one dollar. Catalog not sent otherwise. This catalog costs us twice the price of other catalogs.

Everything in wireless worth while is listed in this catalog. The experienced amateur will tell you to see our catalogue before buying. You are thereby insured against an unwise purchase. It is the Beacon Light to guide you right in the selection of your wireless apparatus. No bigger or better values are obtainable elsewhere. Send for revised price list. It is yours for the asking.

THE WILLIAM B. DUCK CO. 243-245 Superior St., Toledo, Ohio

# MURDOCK

NO. 55

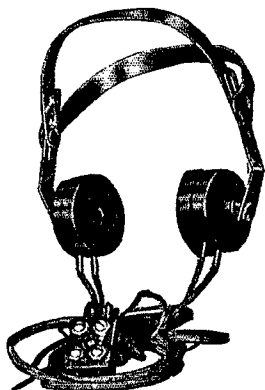

2000 OHM DOUBLE SET

**\$4.50**

3000 OHM DOUBLE SET

**\$5.50**

**M**ade for long and  
**U**seful service in  
**R**adio stations where their  
**D**ependable and sensitive  
**O**peration makes them the  
**C**hoice of those who  
**K**now GOOD 'phones.

**ORDER YOUR SET NOW—**

Try it out thoroughly.  
**IF IT DOESN'T SUIT, SEND  
IT BACK AND GET YOUR  
MONEY**

Bulletin 19 shows a splendid  
line of the type of apparatus  
you want. Send for a copy.

**WM. J. MURDOCK CO.**

65 Carter St.  
**CHELSEA MASS.**

221 SECOND ST., SAN FRANCISCO, CALIF.

## Buy the Best When You Buy

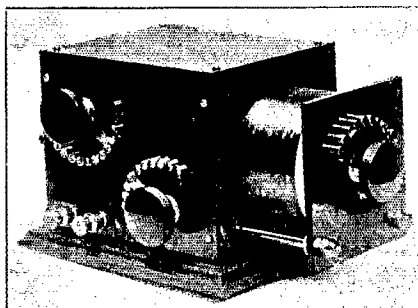

**THE BEST COSTS YOU LESS  
WHEN YOU BUY  
FROM US.**

This 200 to 2500 meter loose coupler  
costs \$18.00 You cannot buy a better  
instrument if you pay more.

## Radio Equipment Company

630V Washington St., Boston, Mass.

New Catalog  
of  
**METEOR**  
**Radio  
Apparatus**



*Mailed Postpaid on Request*

**Quality Apparatus**

**Attractive Prices**

Send for Catalog No. 6245Q Today

**Sears, Roebuck and Co., Chicago.**

# WIRELESS TAUGHT BY MAIL

By the Largest Radio School in the World

Staff of high class government instructors; 16 weeks' course. Now placing our graduates in fine positions. Pay runs from \$110 per month and living expenses, up to \$3500 per year.

## REDUCTION IN TUITION TO GRADUATES

and, under certain conditions, you may obtain the course for practically nothing. We need thousands of operators, inspectors and radio aids. Fascinating work; interesting study; takes only a little bit of your time daily. Write today for illustrated catalogue and details of our profit sharing plan with students.

## SERVICE RADIO SCHOOL

Dept. T, 900-2 Pa. Avenue

Washington, D. C.

# BURGESS "B" BATTERIES

22.5 VOLTS  
15 CELLS

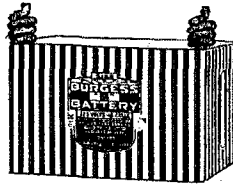

### THREE SIZES

No. 2156—3" x4" x6  $\frac{5}{8}$ "  
No. 5156—2  $\frac{1}{8}$ " x2  $\frac{3}{8}$ " x4  $\frac{1}{8}$ "  
No. 4156—2  $\frac{1}{2}$ " x2" x3  $\frac{3}{8}$ "

BURGESS "B" BATTERY construction is being specified by the Government for its vacuum tube batteries. They have long life, high capacity and noiselessness.

Write for prices and information to

## BURGESS BATTERY COMPANY

Laboratories  
Madison, Wisconsin

Sales Office  
Harris Trust Bldg., Chicago

*Manufacturers of Reliable Instruments  
and  
Distributors of All Prominent Makes of*  
**RADIO APPARATUS**

Everything Essential to the Successful  
Installation of A RADIO STATION

Bunnell Apparatus is Sold by Dealers Everywhere  
Catalog 40-Q on Request

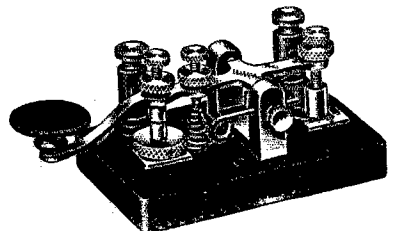

Special Feature—  
The Straight Line Radio Key

**J. H. Bunnell & Co. 32 Park Place, New York**

A New  
Variometer  
for the  
Amateur

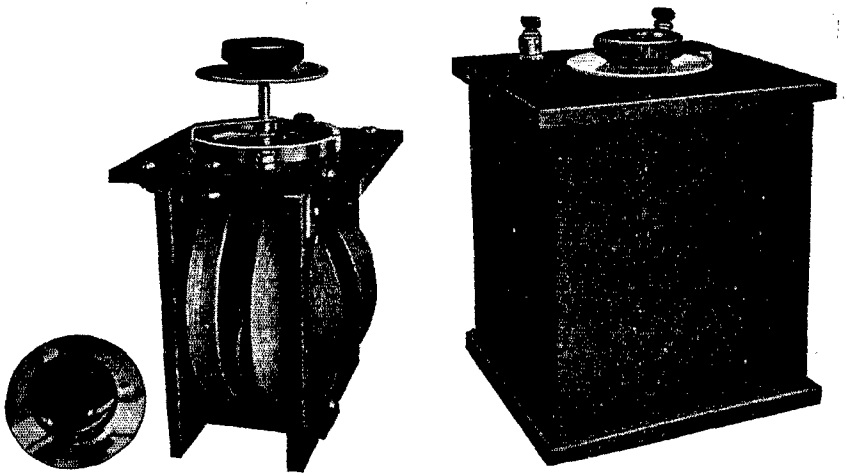

Type S.S. Variometer, in three sizes: maximum inductances, 1 millihenry, 5 millihenries, 20 millihenries. Mounted \$20.00; unmounted \$16.00.

Variometers provide an inductance as easily and gradually variable as a rotary condenser. They are the ideal inductance; efficient, no poor contacts, dead-end losses or capacity losses from multiple taps. Clapp-Eastham Variometers are designed to give the amateur a Precision Instrument at a low price. Compact in size and beautiful in workmanship. Especially designed to minimize distributed capacity. Readily adaptable to panel mounting. Equipped with a special drum switch automatically actuated by the control knob, whereby the coils are in parallel the first half revolution providing an inductance continuously variable thru 360 degrees, giving double the range of adjustment available with other variometers.

Fully described, with other New Developments, in our interesting Bulletin Y.

NEW BULLETIN R OF RECTIFIERS FOR STORAGE BATTERY CHARGING NOW READY.

**CLAPP-EASTHAM COMPANY**

141 MAIN STREET

CAMBRIDGE, MASS.

REMLER RADIO MFG. CO., 62 Post St., San Francisco, Cal., Pacific Coast Representatives

**PAUL UNIPIVOT GALVANOMETER**

TYPE I.

Excellent for  
wing circuits  
of  
vacuum tubes



Resistances  
of  
5, 10, 50 and  
100 ohms

**Rawson Electrical Instrument Co.**  
4 NORFOLK ST., CAMBRIDGE, MASS.



Other AMRAD products that every amateur should use are: AMRAD Detector Stand, AMRAD Antenna Switch, AMRAD Induction Coil--for use where AC is not available. Ask your dealer about AMRAD products, the commercial grade apparatus for amateur use.

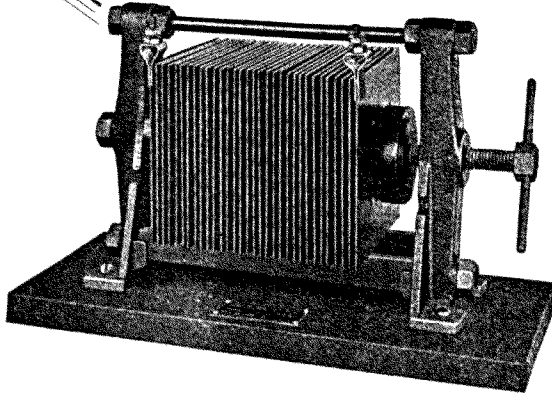

AMRAD  
Quenched Gap  
\$17.50



AMRAD  
Variable Air Condenser



AMRAD  
Detector Stand

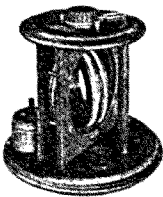

AMRAD  
Variometer

## Now that the ban is off--

there will be more severe government restrictions imposed than ever before.

To secure *three to four times* your present antenna energy, to assure low decrement and so comply with government regulations, amateurs should use the

# AMRAD

## QUENCHED GAP

The AMRAD Quenched Gap does not necessitate the use of 500 cycle generator. Properly operated with a 60-cycle circuit, it will give a 240 spark note.

Our bulletin No. 12, sent at your request, will explain how this may be done.

*Folder, giving detailed specifications of the Quenched Gap will be sent at your request. Address Department R 5.*

# AMERICAN RADIO AND RESEARCH CORPORATION

21 PARK ROW

NEW YORK

*Factory at Medford Hillside, Mass.*

# THE HEART OF THE WIRELESS

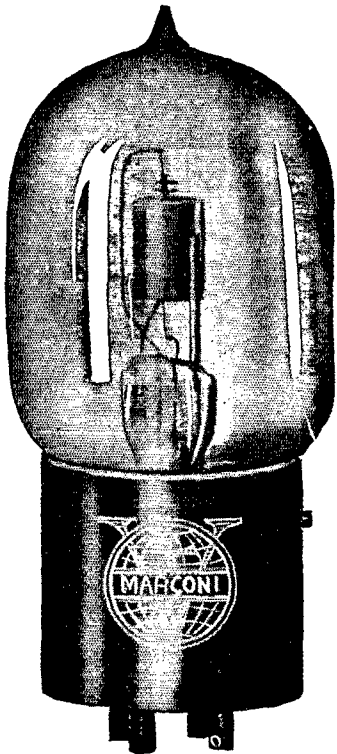

An Amateur Station  
Without a Vacuum Tube  
Is Years Behind the Times

## MARCONI V.T.

### \$7.<sup>00</sup> each

Under agreements recently effected the Marconi V. T. is the only vacuum tube, or audion, which may be sold to amateurs, laboratories, schools of instruction and experimenters.

---

THE APPROXIMATE  
OPERATING LIFE OF  
THE MARCONI V. T.  
IS 1,500 HOURS.

---

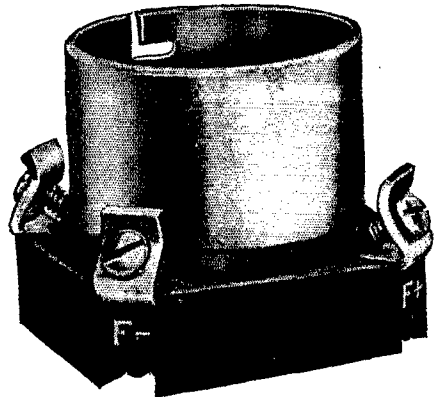

STANDARDIZED SOCKET \$1.50 additional

Fleming Pat. No. 808684  
DeForest Pat. Nos. 841887-879532

Class I.—Designed for use as a detector; operates with plate potential of 20 to 60 volts.

Class II.—Designed for use as an amplifier; plate potentials from 60 to 110 volts may be applied.

Tubes in either class may be used for detection or amplification, but those of Class I are best as detectors, and Class II tubes are superior as amplifiers.

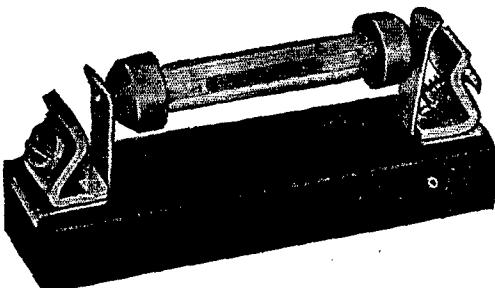

STANDARD RESISTANCE, COMPLETE \$1.00

Send all remittances with order to COMMERCIAL DEPARTMENT

## Marconi Wireless Telegraph Company of America

Sole Distributors for De Forest Radio Telephone & Telegraph Co.

227 BROADWAY, NEW YORK

RETAIL SALES AND EXHIBITION ROOMS, 25 ELM ST., NEW YORK

BRANCH OFFICES:

Schofield Bldg., Cleveland, Ohio

American Bldg., Baltimore, Md.

Insurance Exch. Bldg., San Francisco, Cal.

136 Federal St., Boston, Mass.

301 Commercial Bank Annex, New Orleans, La.

109 South 2nd St., Philadelphia, Pa.

The Marconi Resistance, connected in the circuit between the grid and the filament of the Marconi V. T., is made in the following standard sizes:

½ megohm, 1 megohm, 4 megohms, 6 megohms.

Resistances of any special fractional values up to 6 megohms can be supplied.

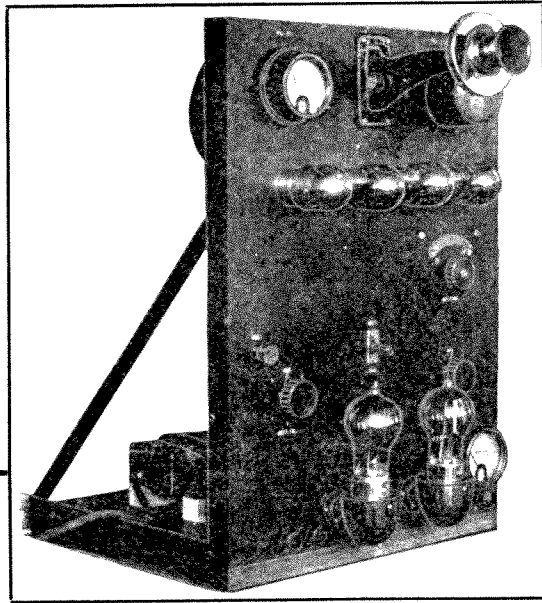

*YOU will eventually use this type of transmitter, now recognised as the most efficient of all low-power systems. Investigate this new De Forest production now. Order immediately to insure early delivery; either thru your regular dealer or direct from us.*

# DE FOREST Wireless Telephone

*The Newest Development in the Radio Field*

A Wireless Telephone that plugs into a lamp socket. A genuine DE FOREST UNDAMPED WAVE RADIOPHONE (and telegraph) OPERATING DIRECT FROM YOUR 60 CYCLE, 110 VOLT HOUSE CURRENT. NO MOTOR-GENERATOR REQUIRED. JUST PLUG IN AND TALK—SIMPLICITY ITSELF.

A greater invention than wireless telegraphy. Absolutely silent in operation. Trouble-proof, foolproof and **only one adjustment required** after which the instrument "stays right." Couldn't possibly be simpler to operate. Practically simultaneous transmission and reception by means of electrically operated relay transfer switch. Marvelous, snappy, clear speech. Voice quality superior to that over a wire. Absolutely stable in operation. Utmost selectivity. No decrement. The panel is divided into three divisions—rectifier, filter and oscillator. The rectifier employs two bulbs thus taking advantage of both halves of the cycle. The filter of inductances and capacities smooths out the ripple, freeing the speech from distortion. The oscillator of four tubes comprises a new circuit of high efficiency both in power output and modulation.

Tested Ranges	{	Telephone 10 to 20 miles Telegraph 50 to 75 miles	}	depending upon aerial height and terrain.
------------------	---	--	---	--

Our actual experience with this set indicates that these ranges can be greatly exceeded.

Send for the DeForest Catalogue Q which describes and illustrates many Radio Instruments of superior workmanship and efficiency. Sent Postpaid for 10 cents.

PRICE COMPLETE, INCLUDING BULBS,

**\$200.00**

## DE FOREST RADIO TELEPHONE & TELEGRAPH COMPANY

*Inventors and Manufacturers of Amateur and Commercial Radio Apparatus*

1415 SEDGWICK AVENUE, NEW YORK CITY.

# The Plate Battery Problem Solved!

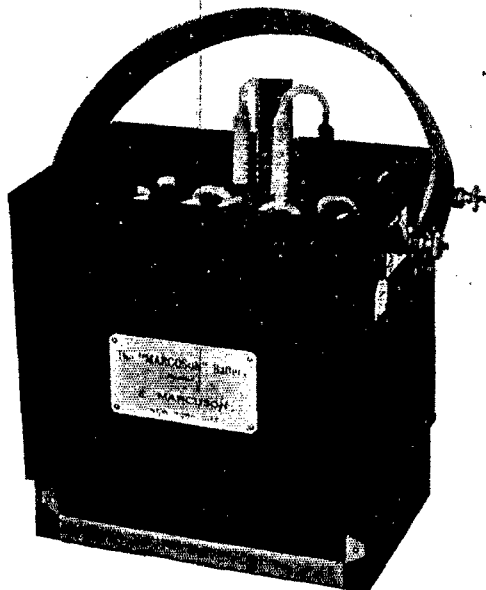

We have been appointed  
Sole Distributors of the  
**Marcuson "B" Battery.**

Among the numerous advantages possessed by this battery may be mentioned its lightness, compactness, reliability and *Small Cost.*

It may be readily charged from any D. C. lighting circuit.

**40 Volts. Overall Dimensions : 6 in. x 6 in. x 4 in. Weight : 5 lbs.**

***PRICE, \$12.00***

This type of battery has been in use for over 10 years by the largest Electrical Manufacturers, Cable Repair Ships, Technical Institutions, etc.

All parts can be replaced by the user at less cost than new dry batteries can be bought.

**This is but ONE of our MANY radio products.**

Write for our Catalog No. 1.

**WIRELESS IMPROVEMENT COMPANY**

**Radio Engineers**

**Manufacturers and Distributors**

**47 WEST STREET**

**NEW YORK, U. S. A.**